

# SLV NUMINOS®

A downlight and spotlight system.  
A thousand possibilities.

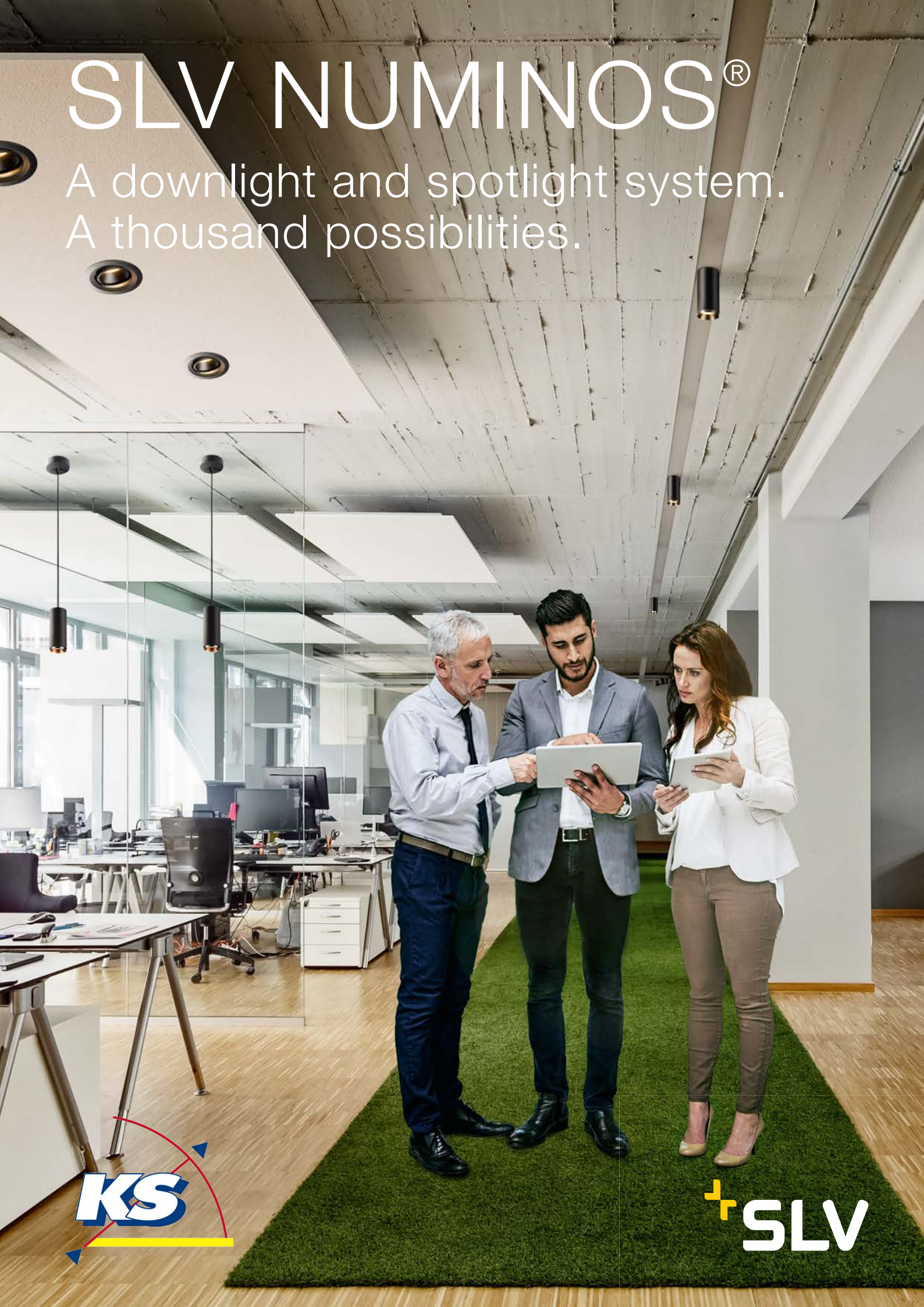

**KS**

**SLV**

always  
up to date!

---

download the current pricelist at

[KS-Light.co.uk/price\\_list\\_NUMINOS](https://KS-Light.co.uk/price_list_NUMINOS)

or scan the qr-code below!



Find our terms and conditions for business customers [here](#)



## KS and SLV: strong partners in lighting for more than 30 years

### PICK-UP CENTER IN ESSEN

For more than 30 years KS Licht- und Elektrotechnik GmbH complements the products and services of SLV with a variety of services. We maintain a pick-up center for SLV products in the heart of the Ruhr area, where you can pick up the goods ordered from us at short notice.

### EXPERIENCE SLV LUMINAIRES LIVE

We present a large selection of SLV luminaires on more than 300 m<sup>2</sup> of exhibition space. Here, our professionally trained consultants and lighting designers will advise you personally. At the same time, you can use our exhibition to present our luminaires to your customers in terms of function and effect. Convince yourself of the quality of our outdoor luminaires in the outdoor exhibition.

### FREE LIGHTING DESIGN

We develop practical lighting solutions with you and according to your needs. Whether for business premises, salesrooms or private ambience: our lighting designers always have the right concepts for a demand-oriented and energetically sensible solution. We will be happy to calculate the payback time of your new, energy-saving LED lighting for you.

### KS MULTI-BRAND LUMINAIRES ONLINE SHOP

In our business online shop at [www.KS-Light.co.uk](http://www.KS-Light.co.uk) you will find everything that supports you in your daily work:

- Current special offers and new products
- Online check of product availability
- Find and order all spare parts easily
- Quick order form
- All catalogues for downloading or as a flip catalogue with Product links
- Specification texts, light distribution curves/LDT plug-ins and quick calculation tables

**KS Licht- u. Elektrotechnik GmbH**  
**Manderscheidstr. 8c**  
**45141 Essen**

Tel.: +49 (0)201-89924-0  
Fax: +49 (0)201-89924-124

Onlineshop: [www.KS-Light.co.uk](http://www.KS-Light.co.uk)  
Internet: [www.KS-Germany.com](http://www.KS-Germany.com)  
Email: [Verkauf@KS-Germany.com](mailto:Verkauf@KS-Germany.com)

### Visit us on site or call us:

Monday-Thursday continuously from 08.00 hrs to 16.30 hrs  
Friday continuously from 08.00 hrs to 15.00 hrs

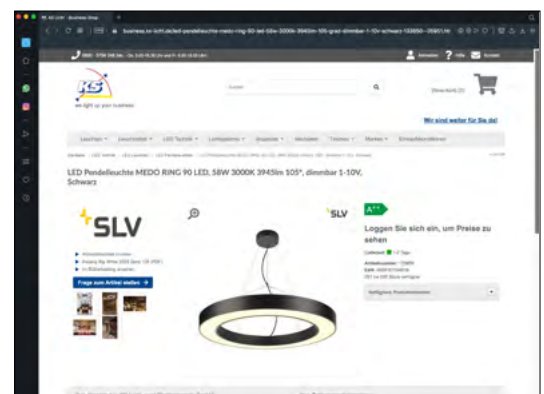

Scan the link to our quick order form and get up-to-date information about the availability of goods!



[www.KS-Light.co.uk/quick-order-form](http://www.KS-Light.co.uk/quick-order-form)

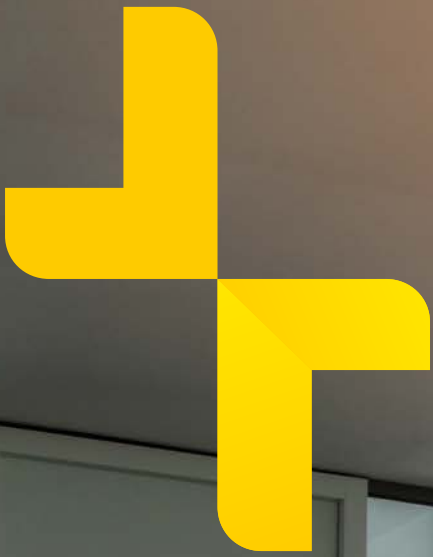



# SLV NUMINOS® DOWNLIGHTS AND SPOTLIGHTS

---

The SLV NUMINOS® lighting system offers constant lighting characteristics and modern design for all uses. Let yourself be inspired.



**AVAILABLE** !  
FROM NOVEMBER 2020

# SLV NUMINOS® ONE LIGHTING SYSTEM – A THOUSAND POSSIBILITIES.

THE PERFECT  
LIGHTING  
SOLUTION FOR  
EVERY CONTEXT.

THE FREELY CONFIGURABLE LIGHTING SYSTEM  
THAT CASTS A GOOD LIGHT ON EVERY SETTING.

No two projects are the same. But many projects demand a coherent lighting and design concept. SLV NUMINOS® is a perfectly coordinated lighting system that harmonises function, design and technology. For planners and doers. For every need. For maximum variety with minimum effort.

**SLV  
NUMINOS®**

HIGH-PERFORMANCE LED MODULE  
WITH BRILLIANT COLOUR RENDERING

WIDE SELECTION OF DOWNLIGHTS  
AND SPOTS FOR A HARMONIOUS  
DESIGN CONCEPT.



# MORE FREEDOM WITH SYSTEM.

WHATEVER YOU'RE PLANNING –  
THE NUMINOS® LIGHTING SYSTEM  
CREATES SPACE FOR NEW IDEAS.

---



The NUMINOS® lighting system offers constant lighting characteristics and modern design for all uses:

- for office spaces
- shops & boutiques
- hotels & gastronomy
- at home
- and much more

From hotels and offices to commercial or private rooms. From application to technology to detailed design: NUMINOS® modular downlights and spotlights can be configured exactly as required, depending on the design or space in question. And the more multifaceted your project is, the more you benefit from the NUMINOS® lighting system.

Lighting that  
won't dominate.



NUMINOS®  
MOVE M, DL

Item No.  
1003553

NUMINOS® XL  
DL

Item No.  
1003985

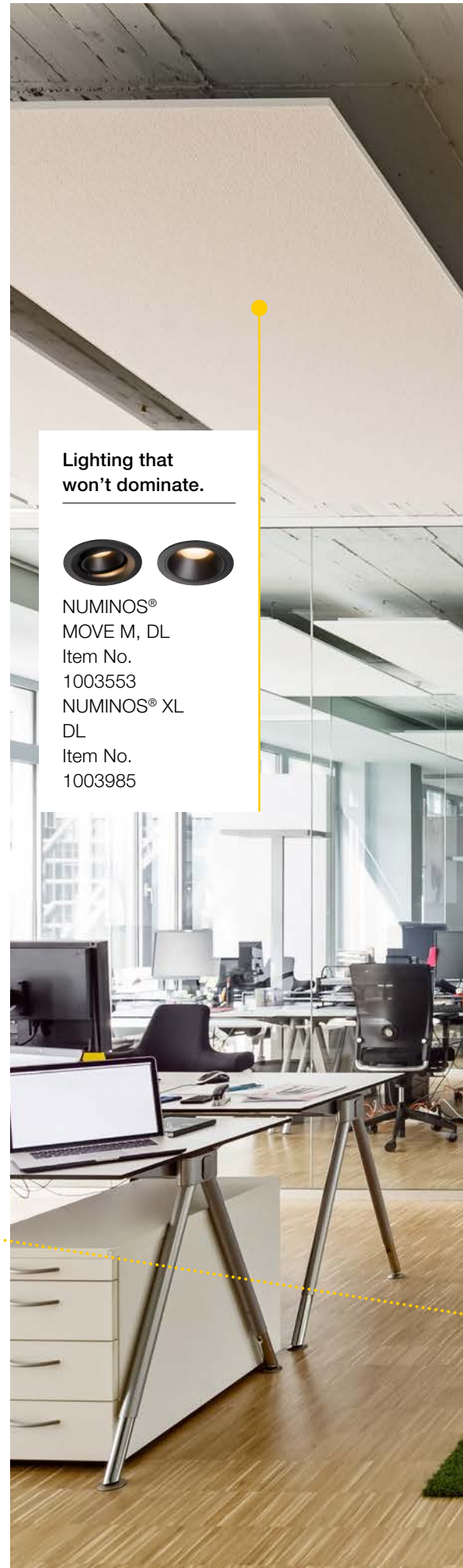



Highlights that shine down.



NUMINOS® S, CL  
Item No.  
1004139

Free for all dimensions.



NUMINOS® L,  
3-circuit  
Item No.  
1004554

Individually adaptable for every room.



NUMINOS® L, PD  
Item No.  
1004530

UNIQUE VARIETY,  
SHARED HIGHLIGHTS.

Choose between:

- Downlight or spotlight
- Various sizes and diameters
- Housing colours (black/white)
- Reflector variants
- Pivoting or rigid versions
- Performance classes

The different variants feature:

- High-performance LED module with the light colours 2700K/3000K/4000K
- Colour quality CRI>90
- Glare rating UGR min. <22



## DOWNLIGHTS

Available in seven versions (68-75mm to 176-186mm) with high-performance LED module in three light colours (2700K, 3000K, 4000K) and glare ratings (UGR 16, 19, 22)

Selectable reflectors with half beam angles of 20°, 40° or 55°.

Various effect filters (frosted / prismatic / elliptical / honeycomb) available as accessories.

The decorative ring can be selected in white, black or chrome as a visible border.

NUMINOS® downlights are available as fixed or swivelling versions (4x fixed and 3x swivelling and rotating).



### Accessory with system:

You can easily add an optional driver (on/off, phase dimming, DALI) and suitable diff users using the colour coding system.

You can find drivers and diff users for the SLV NUMINOS® Downlight system on pages 42-43.

# ONE LIGHTING SYSTEM INTELLIGENTLY DESIGNED IN EVERY DETAIL

Thanks to the wide selection of modules, there is a suitable solution to every need. Fixed configuration. Fast and safe to install.



## SPOTLIGHTS

Available in three housing sizes (65x155mm, 85x175mm, 100x203mm) with high-power LED module in three light colours (2700K, 3000K, 4000K).

Thanks to the built-in LED driver (phase dimming, DALI), all spotlights are suitable for direct connection to 230V mains voltage.

Selectable lenses with half beam angles of 24°, 36° or 60°.

NUMINOS® spotlights are available as swivelling or fixed ceiling spots, pendant lights and as spots for 3-circuit track systems.



### Strong delivery performance.

For more than 40 years SLV has been one of the best known lighting manufacturers in Europe. You too can rely on quality that has been developed and tested in Germany along with reliable delivery performance. Our stock items can be delivered in less than 24 hours within Germany (48 hours in Europe). With our freely configurable luminaires, you will be notified of the delivery time as soon as you confirm the final configuration.

### Easy to install.

Because efficiency always pays off, SLV lights are easy, quick and safe to install. Connection via mounting plate, track system, quick-release coupling, spring clips and colour-coded drivers for downlights offers a key advantage: it saves you time and effort – and therefore reduces cost.



# A LIGHTING SYSTEM. FOR EVERY SCENARIO.

For success under all conditions, you need team players who shine with individual strengths. Discover the applications for which the individual NUMINOS® lights are particularly well suited.

## Downlights.

Unobtrusive, modern and space-saving lighting that directs the gaze to particular objects or the room in general: the downlights in the NUMINOS® lighting system can be used variably in commercial and private settings.



To help focus on what really matters in meeting rooms.



NUMINOS® S  
DL  
Item No.  
1003798

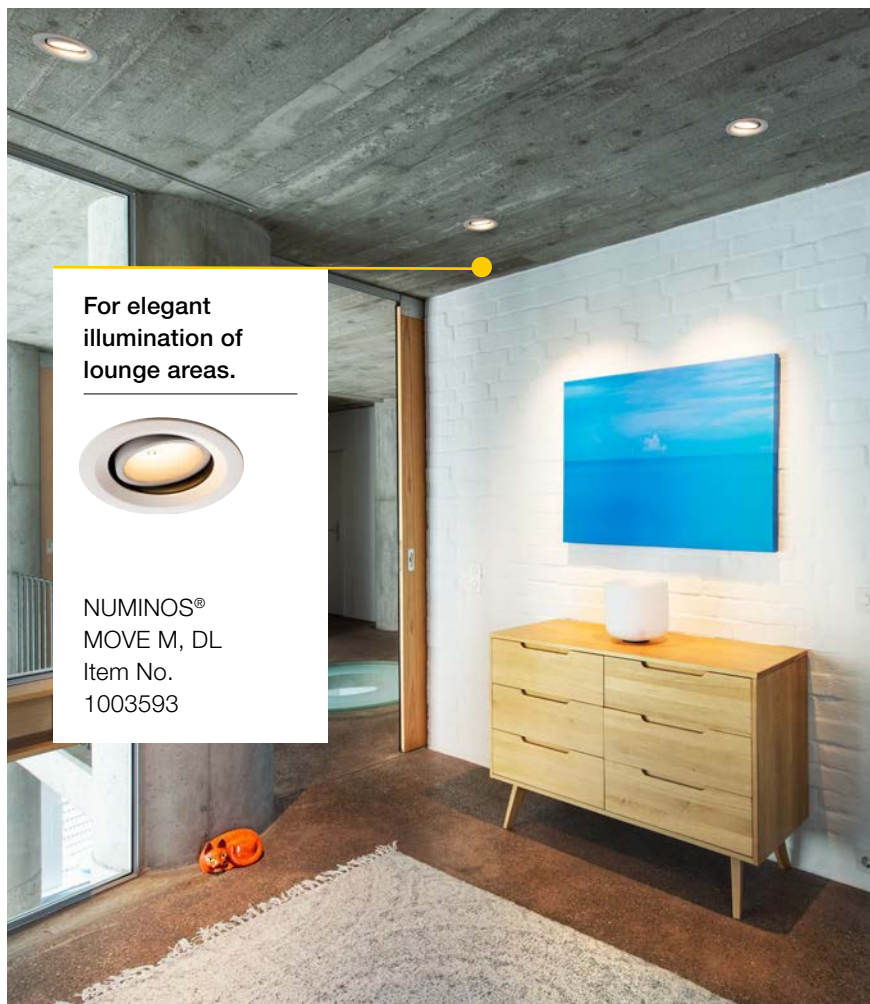

For elegant illumination of lounge areas.



NUMINOS®  
MOVE M, DL  
Item No.  
1003593



To give highlights  
an extra special  
touch.



NUMINOS® M  
DL  
Item No.  
1003809

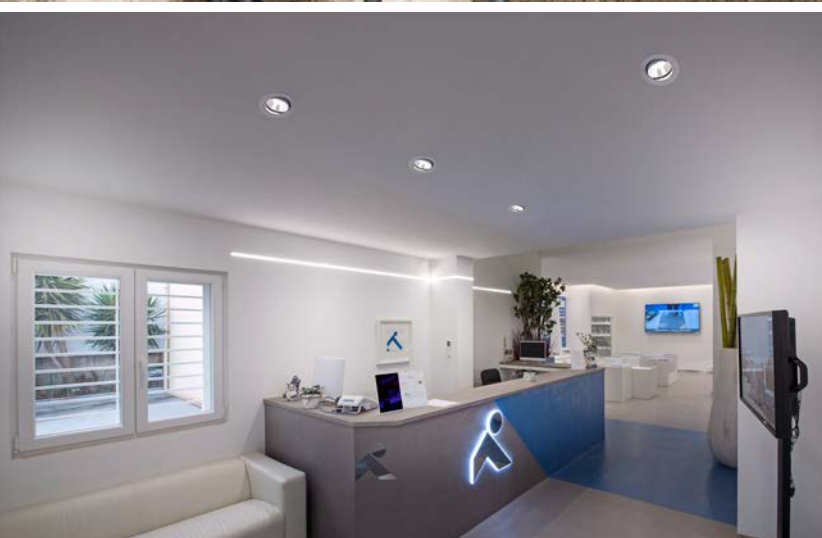

When you want your  
lighting to promote  
a sense of wellbeing.



NUMINOS®  
MOVE M, DL  
Item No.  
1003620

**Individually designed illumination.**

Thanks to the large selection of reflectors on offer, the NUMINOS® lighting system is suitable for accent lighting as well as for uniform illumination of work areas, corridors and offices.



For safe illumination of work surfaces.



NUMINOS® S  
DL  
Item No.  
1003795

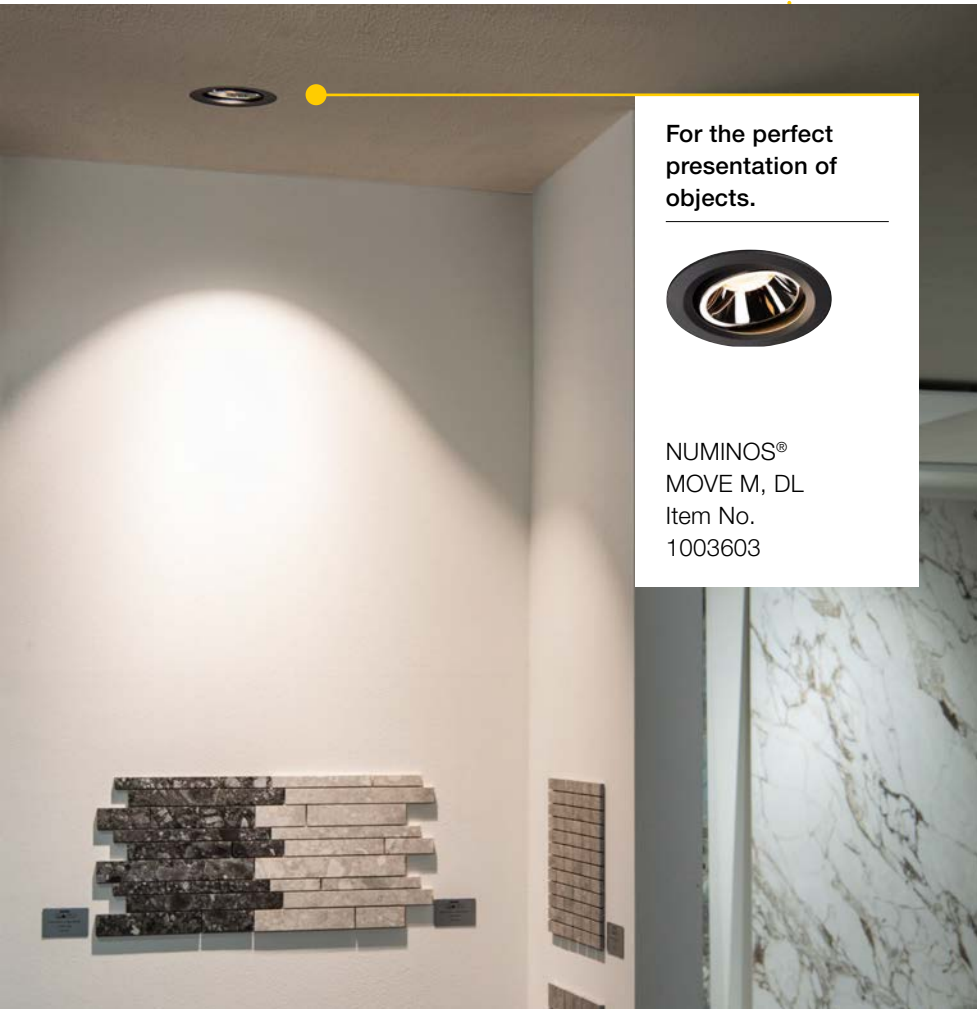

For the perfect presentation of objects.



NUMINOS®  
MOVE M, DL  
Item No.  
1003603

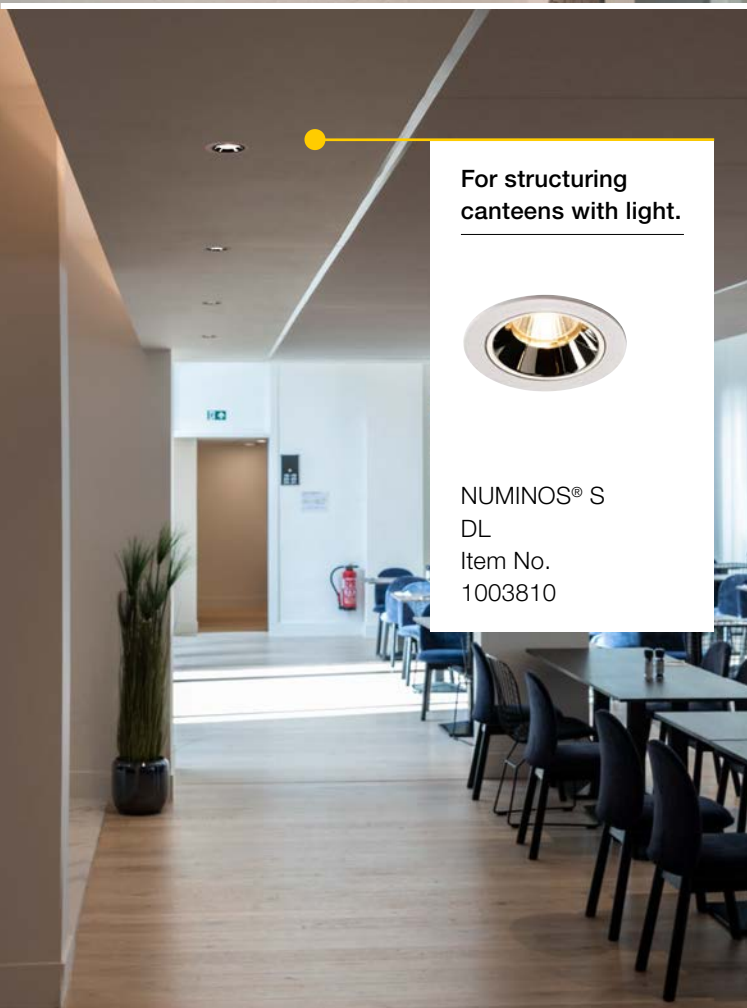

For structuring canteens with light.



NUMINOS® S  
DL  
Item No.  
1003810

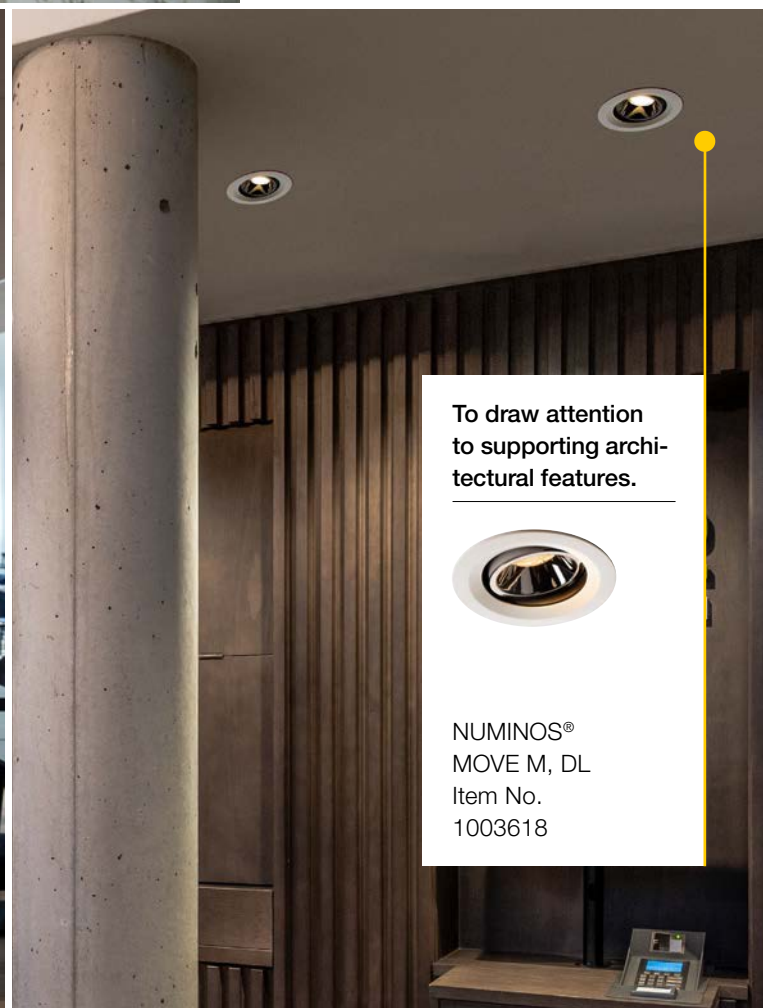

To draw attention to supporting architectural features.



NUMINOS®  
MOVE M, DL  
Item No.  
1003618

Highlight your  
favorite piece  
of furniture.



NUMINOS®  
MOVE L, DL  
Item No.  
1003664

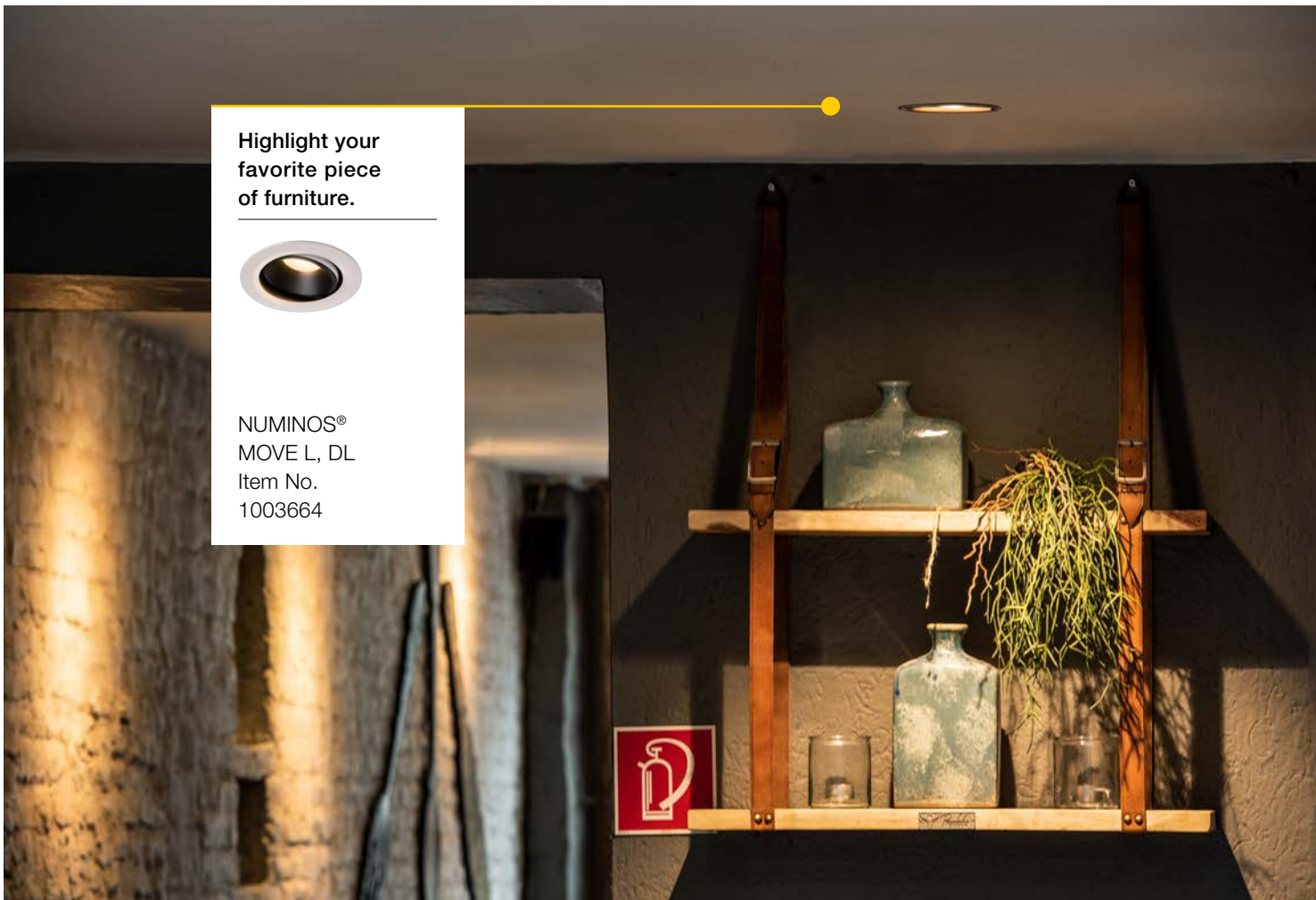

For the illumination  
of corridors.



NUMINOS®  
MOVE XL, DL  
Item No.  
1003736





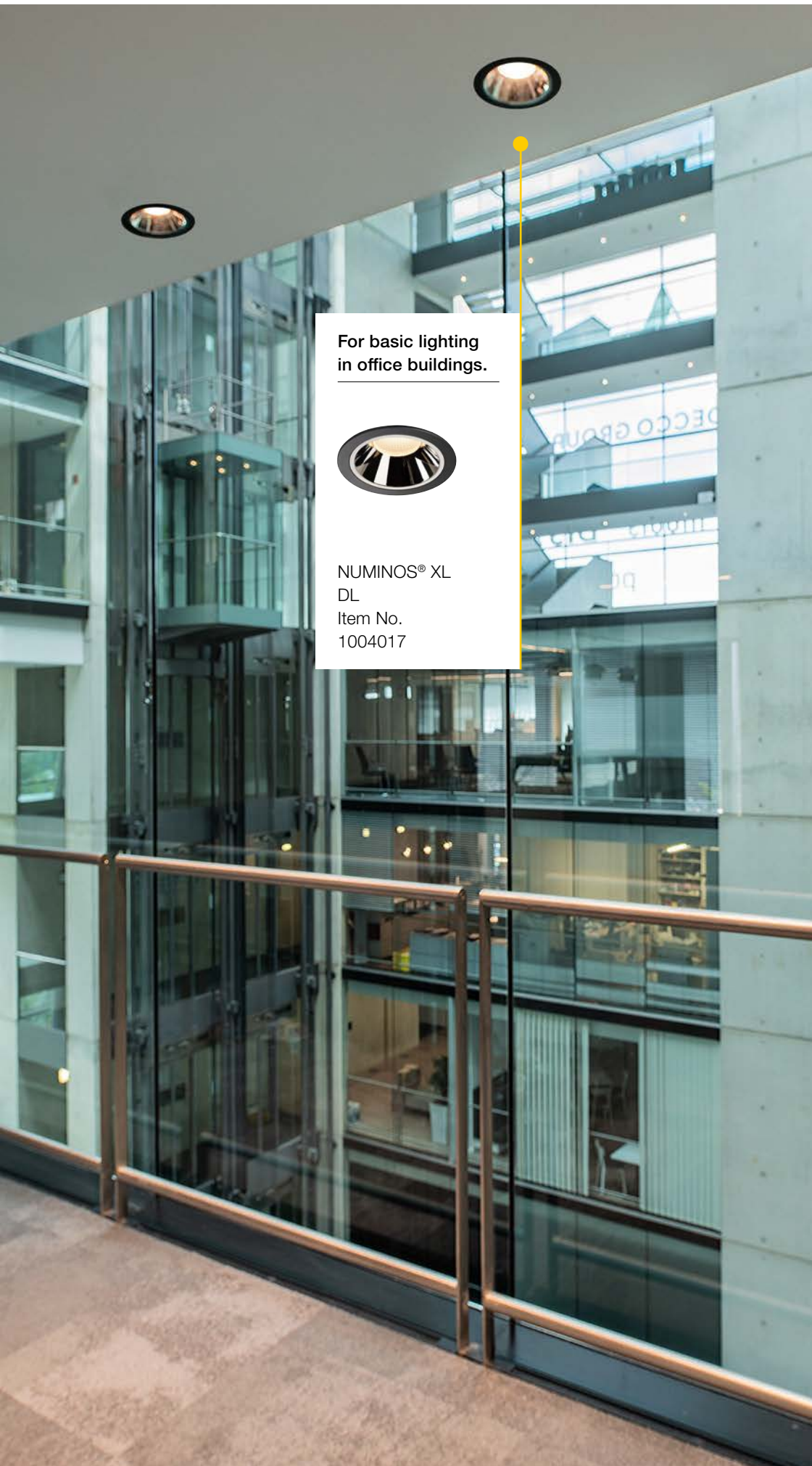

For basic lighting  
in office buildings.



NUMINOS® XL  
DL  
Item No.  
1004017

**Can be perfectly  
combined.**

Thanks to the large number of light colour temperatures and drivers, the NUMINOS® lighting system can be used in many different ways and combined perfectly.

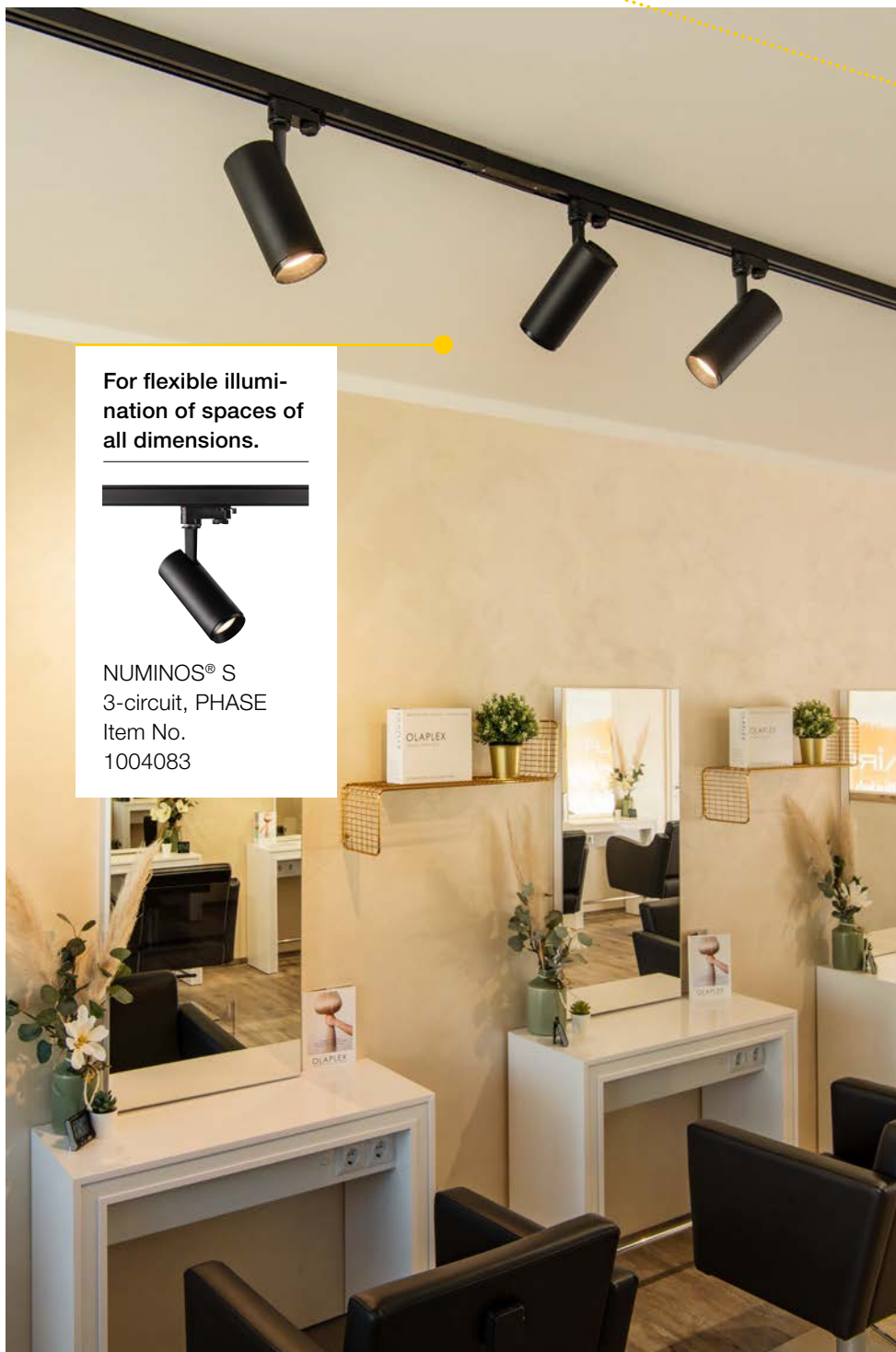

For flexible illumination of spaces of all dimensions.



NUMINOS® S  
3-circuit, PHASE  
Item No.  
1004083

Add texture to your favorite furniture.



NUMINOS® S  
CL, PHASE  
Item No.  
1004135

### Spotlights.

Shops and boutiques as well as restaurants, bars, studios, and offices – every space depends on expert accent lighting. Spotlights can be used to illuminate larger spaces as well as for targeted lighting.





To create  
a welcoming  
atmosphere.



NUMINOS® L  
PD, DALI  
Item No.  
1004435

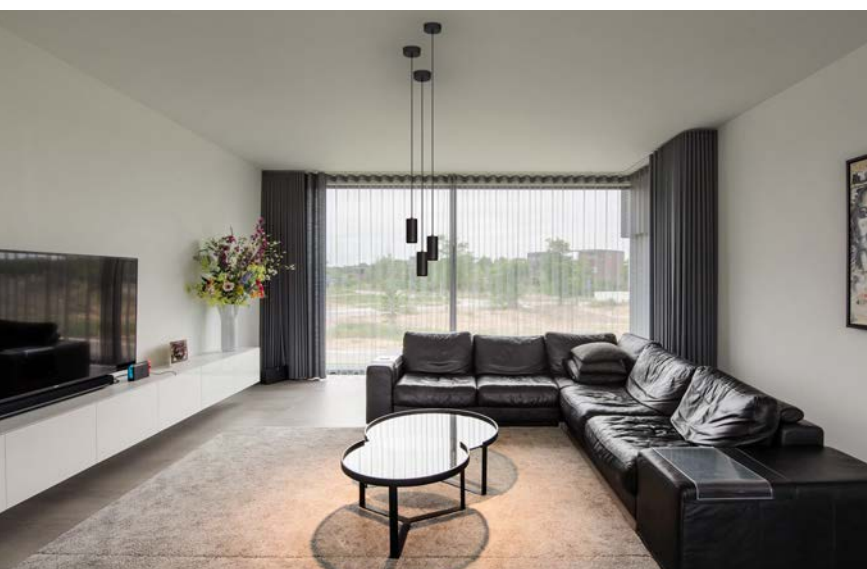

For a cosier home.



NUMINOS® M  
PD, PHASE  
Item No.  
1004154

For effective  
perception of  
characteristics.



NUMINOS® L  
3-circuit, PHASE  
Item No.  
1004287



For artistic  
accentuation of  
the highest level.



NUMINOS® L  
CL, PHASE  
Item No.  
1004207

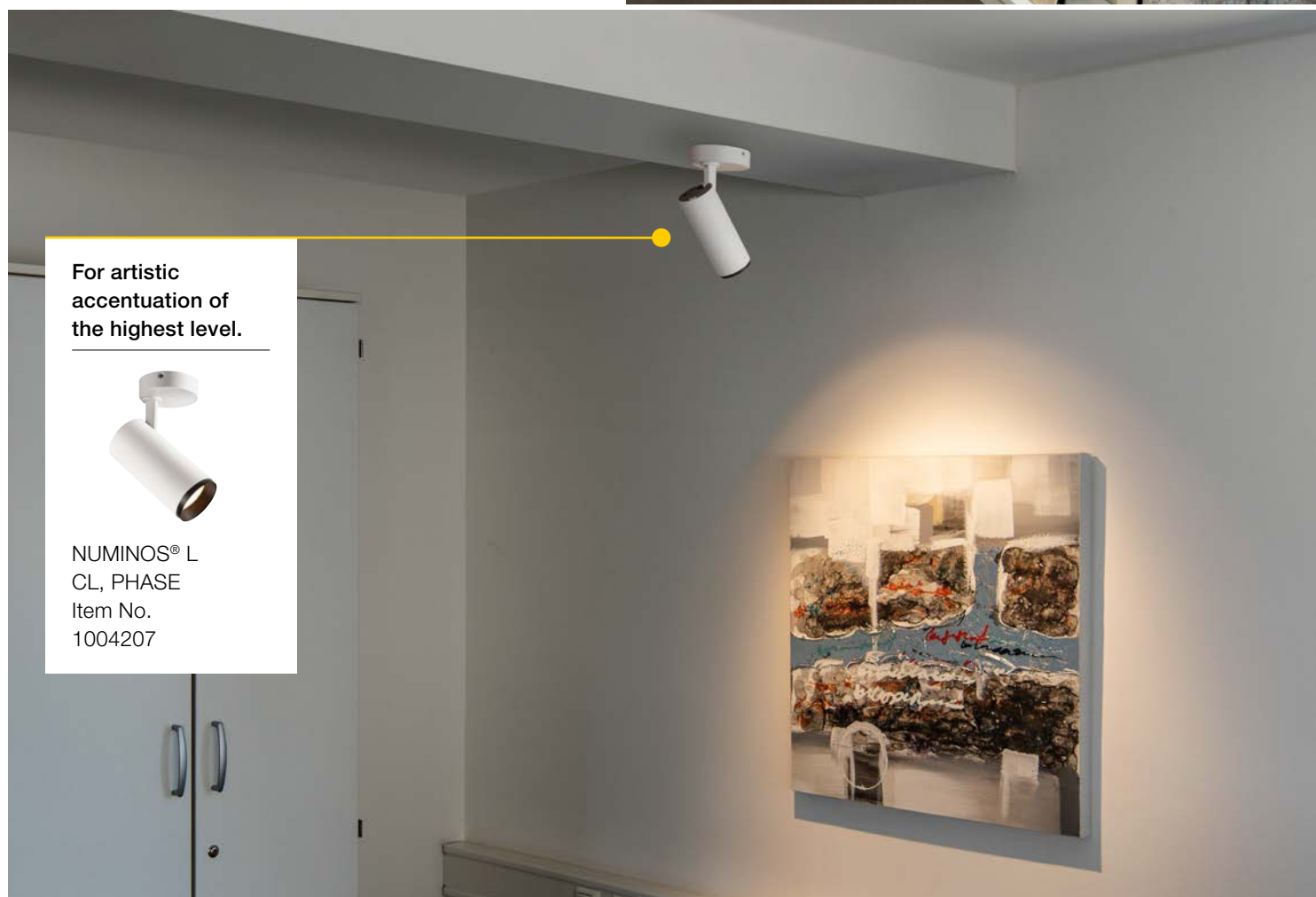

To give office spaces a striking structure.



NUMINOS® M  
CL, DALI  
Item No.  
1004519

### Flexibility in all its facets.

Whether you're looking to create atmospheric room lighting or effective accent lighting – with the right spotlights, anything is possible. The rotating and pivoting versions in particular, as well as the track spotlights of the NUMINOS® lighting system, meet the highest demands in terms of flexibility.

**Subtly decorative.**

NUMINOS® spots and pendant lights are the right choice especially where the light source is not intended to be a decorative feature. Their straightforward simplicity does not distract from the interior design, but sets the scene. They skilfully perform the lighting task required.

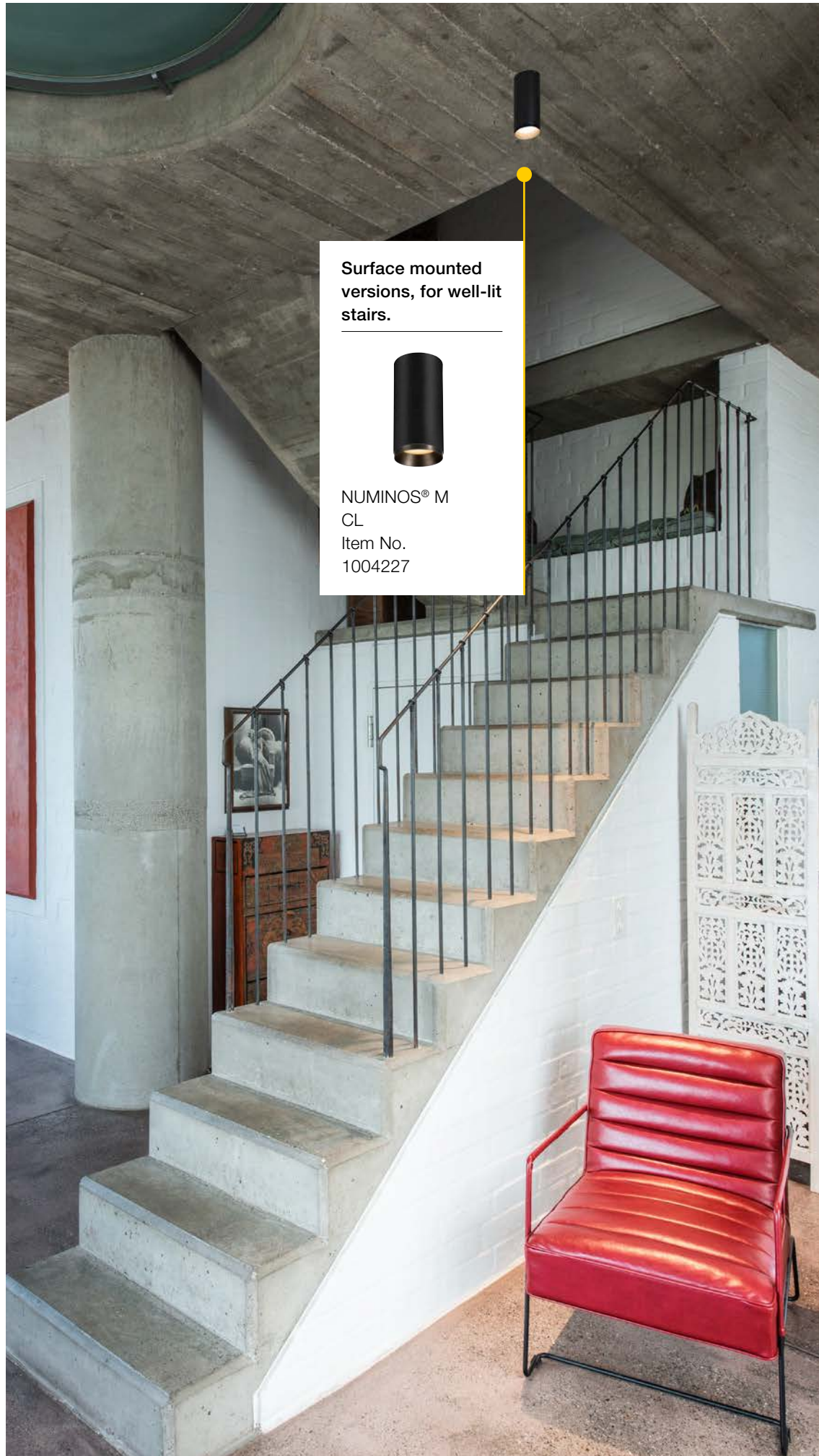

Surface mounted versions, for well-lit stairs.



NUMINOS® M  
CL  
Item No.  
1004227



Draws the eye  
to counters and  
tables.



NUMINOS® S  
PD, DALI  
Item No.  
1004447

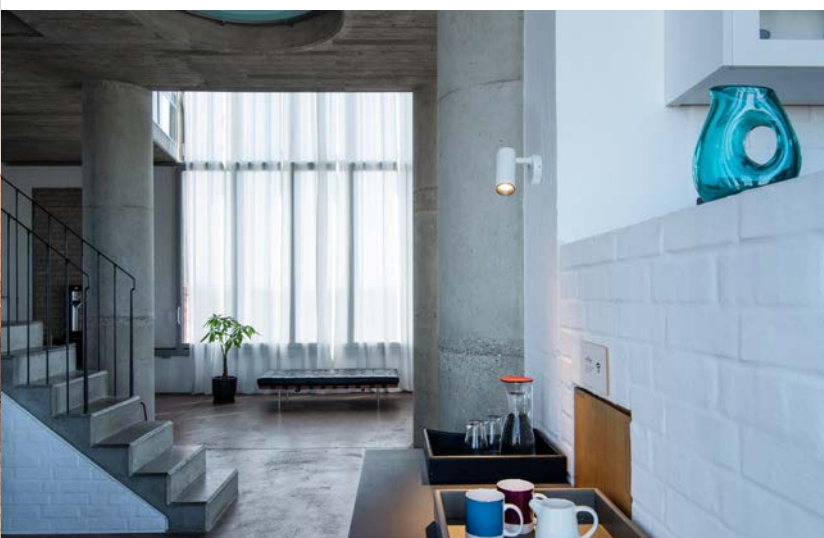

For accentuating  
furnishing objects.



NUMINOS® S  
CW  
Item No.  
1004110



**Collected inspiration?**

Have you collected inspiration on the NUMINOS® website and landed in the configurator via an application scenario? Then the technical selection options are already optimally preset.

# CONFIGURE ONLINE. WITH A SYSTEM.

Your dream light in just a few steps – the SLV NUMINOS® online configurator makes it possible.

Whether spotlights or downlights – our online configurator will get you to your goal quickly. Choose between a detailed or a room view to get a visual preview of your planned project.

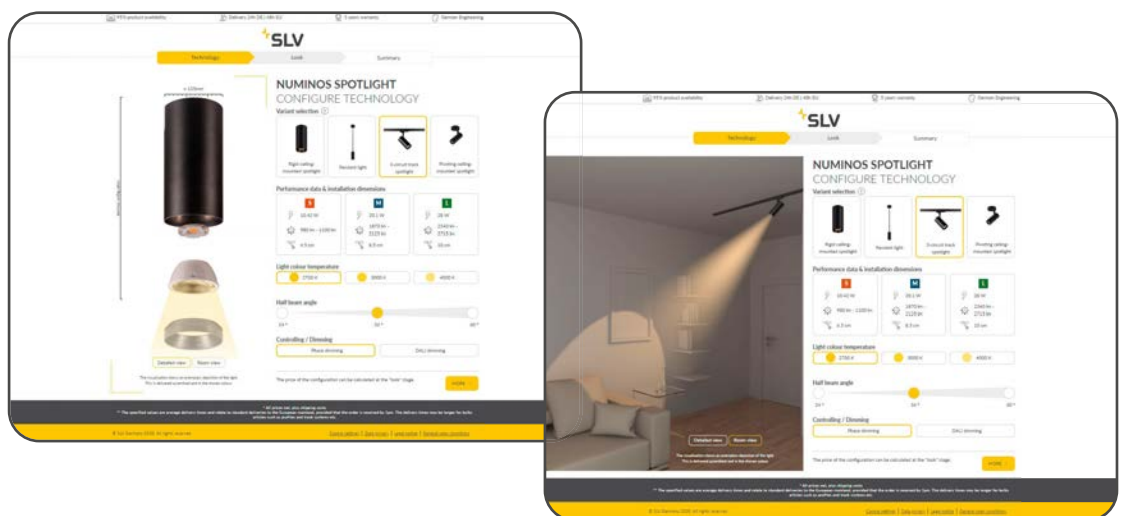

**Do you want to configure your dream light right now?**

**Head to the SLV NUMINOS® online configurator here:**

[www.KS-Light.co.uk/numinos-configurators-en](http://www.KS-Light.co.uk/numinos-configurators-en)



## DOWNLIGHTS



### Select the technical features

Choose the swivelling or rigid version and specify the output and the associated installation dimensions and luminous intensity. The light colour temperature can be selected in three levels from warm white to neutral white. All that remains is to select the appropriate beam angle and the technology is configured.

### Configure the look

By selecting a black or white housing and a decorative ring in black, white, or chrome, you can match the appearance of any room. You can see immediately how much your downlight will cost in the planned configuration.

### Add optional accessories

When it comes to downlight accessories, the configurator offers optional control/dimming (on/off, phase dimming, DALI), matching diffusers and glare control via honeycomb louvre.

### Summary

Check your configuration before you add the downlight to your shopping cart. Or add it to your wishlist to complete the purchase later. You can also download useful lighting design files, data sheets and other documents.

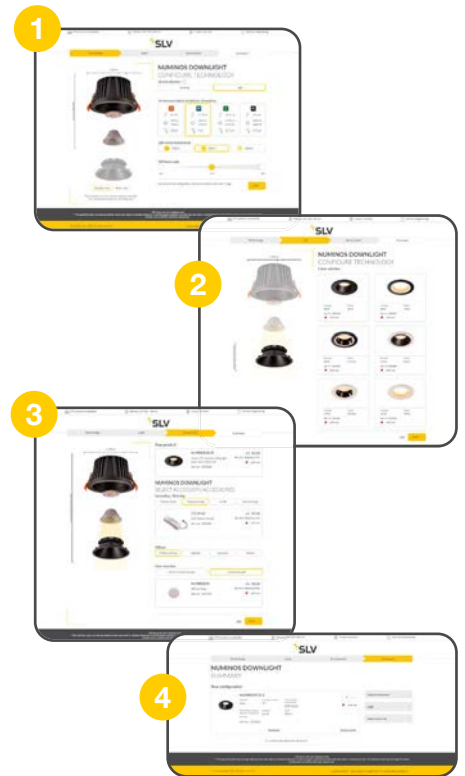

## SPOTLIGHTS

### Select the technical features

Depending on your requirements, select your desired spotlight from the four available mounting types and housings. When you select the output, you also specify the light intensity and light diameter. This is followed by light colour temperature and beam angle. And because the LED driver is permanently installed in the spotlights, you only need to decide between phase dimming or DALI dimming.

### Configure the look

Black or rather white? Your requirements, personal preferences or the design concept to be fulfilled may influence the housing colour, but not the apparent price.

### Summary

You should also check the configuration of the spotlights before putting in your shopping cart. And of course, as with the downlights, functions such as the wishlist or the download of useful documents are available here.

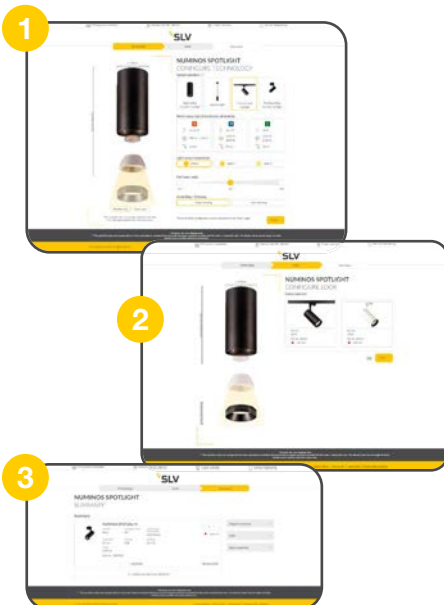

STILL UNSURE ABOUT SOMETHING?

Scan me to view a video that shows how to configure NUMINOS® lights.



# HERE AND NOW TO THE GOAL!

Configure your light with the SLV NUMINOS® brochure.



## Put together your dream lighting over the next pages.

The following product overviews will help you reach your goal easily: scroll to your desired light type, follow the columns from left to right and make your individual selection. At the end, you will find the relevant item number for direct ordering.

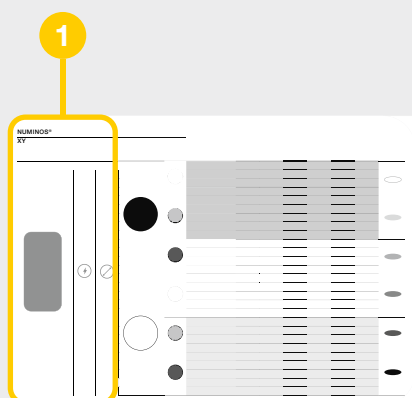

### STEP 1

#### SPOTLIGHT OR DOWNLIGHT?

Choose the most suitable light type for your needs. The diameter (downlights) or housing size (spotlights) are coupled with the total wattage.

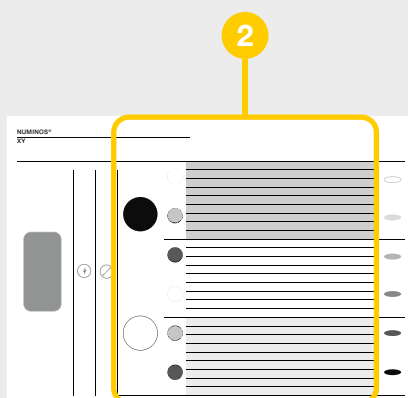

### STEP 2

#### TECHNICAL CONFIGURATION & SELECTION OF DETAILS

Column by column, you can select optical and technical attributes such as housing colour or decorative colours, the colour temperature, half beam angle and more.

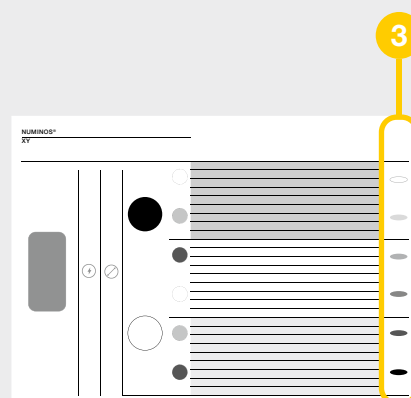

### STEP 3

#### PRODUCT

Get a visual impression of your fully configured light and order it right away using the relevant item number.

# NUMINOS® S



## DL



**Product details:**

250mA  
 Premium LED with CRI>90  
 Power consumption: 8.6W  
 Material: aluminium/polycarbonate (PC)  
 Installation dimensions: Diameter: 6.8 cm D: 5.5 cm

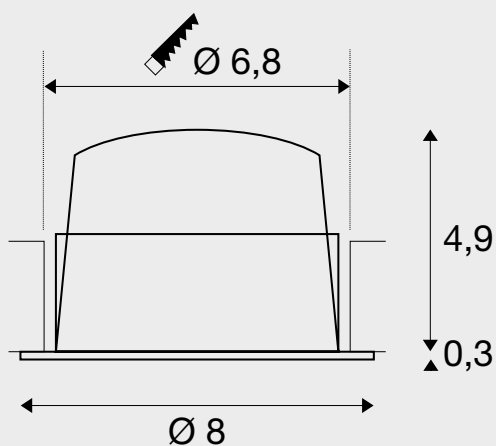

**Tip:**

Low-voltage plug  
 Driver not included

You can find suitable drivers and diffusers on pages 42-43.



black

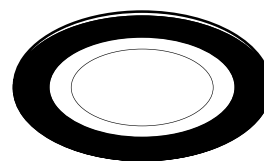

black



white



chrome



black

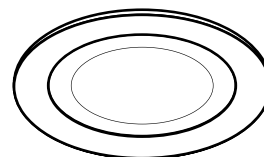

white



white

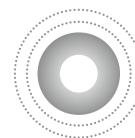











chrome



Leaf springs for installation in solid ceilings are included.



				ITEM NO.	
2700K	670lm	20°	18	<b>1003769</b>	
	670lm	40°	19	<b>1003772</b>	
	670lm	55°	21	<b>1003775</b>	
3000K	690lm	20°	18	<b>1003793</b>	
	690lm	40°	18	<b>1003796</b>	
	690lm	55°	20	<b>1003799</b>	
4000K	730lm	20°	18	<b>1003817</b>	
	730lm	40°	19	<b>1003820</b>	
	730lm	55°	21	<b>1003823</b>	
2700K	720lm	20°	19	<b>1003770</b>	
	720lm	40°	18	<b>1003773</b>	
	720lm	55°	20	<b>1003776</b>	
3000K	730lm	20°	18	<b>1003794</b>	
	730lm	40°	18	<b>1003797</b>	
	730lm	55°	20	<b>1003800</b>	
4000K	790lm	20°	19	<b>1003818</b>	
	790lm	40°	18	<b>1003821</b>	
	790lm	55°	20	<b>1003824</b>	
2700K	690lm	20°	16	<b>1003771</b>	
	690lm	40°	16	<b>1003774</b>	
	690lm	55°	19	<b>1003777</b>	
3000K	700lm	20°	16	<b>1003795</b>	
	700lm	40°	16	<b>1003798</b>	
	700lm	55°	18	<b>1003801</b>	
4000K	750lm	20°	16	<b>1003819</b>	
	750lm	40°	16	<b>1003822</b>	
	750lm	55°	19	<b>1003825</b>	
2700K	670lm	20°	18	<b>1003781</b>	
	670lm	40°	19	<b>1003784</b>	
	670lm	55°	21	<b>1003787</b>	
3000K	690lm	20°	18	<b>1003805</b>	
	690lm	40°	18	<b>1003808</b>	
	690lm	55°	20	<b>1003811</b>	
4000K	730lm	20°	18	<b>1003829</b>	
	730lm	40°	19	<b>1003832</b>	
	730lm	55°	21	<b>1003835</b>	
2700K	720lm	20°	19	<b>1003782</b>	
	720lm	40°	18	<b>1003785</b>	
	720lm	55°	20	<b>1003788</b>	
3000K	730lm	20°	18	<b>1003806</b>	
	730lm	40°	18	<b>1003809</b>	
	730lm	55°	20	<b>1003812</b>	
4000K	790lm	20°	19	<b>1003830</b>	
	790lm	40°	18	<b>1003833</b>	
	790lm	55°	20	<b>1003836</b>	
2700K	690lm	20°	16	<b>1003783</b>	
	690lm	40°	16	<b>1003786</b>	
	690lm	55°	19	<b>1003789</b>	
3000K	700lm	20°	16	<b>1003807</b>	
	700lm	40°	16	<b>1003810</b>	
	700lm	55°	18	<b>1003813</b>	
4000K	750lm	20°	16	<b>1003831</b>	
	750lm	40°	16	<b>1003834</b>	
	750lm	55°	19	<b>1003837</b>	

# NUMINOS® M



## DL



**Product details:**

500mA  
 Premium LED with CRI>90  
 Power consumption: 17.5W  
 Material: aluminium/polycarbonate (PC)  
 Installation dimensions: Diameter: 9 cm D: 7.5 cm

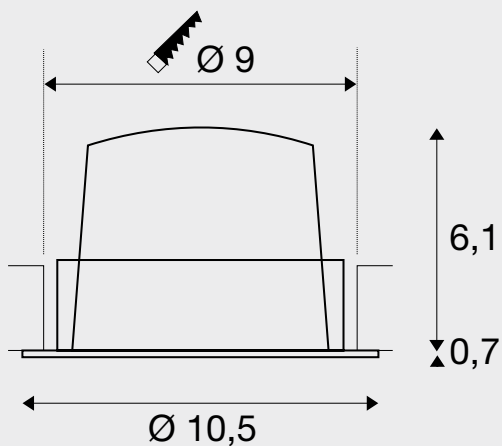

**Tip:**

Low-voltage plug  
 Driver not included

You can find suitable drivers and diffusers on pages 42-43.



black

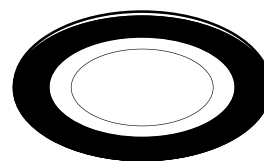

black



white

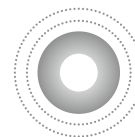

chrome



black

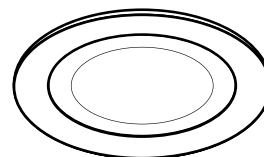

white



white



chrome



Leaf springs for installation in solid ceilings are included.



				ITEM NO.	
2700K	1460lm	20°	19	<b>1003841</b>	
	1460lm	40°	20	<b>1003844</b>	
	1460lm	55°	21	<b>1003847</b>	
3000K	1500lm	20°	19	<b>1003865</b>	
	1500lm	40°	20	<b>1003868</b>	
	1500lm	55°	21	<b>1003871</b>	
4000K	1600lm	20°	19	<b>1003889</b>	
	1600lm	40°	20	<b>1003892</b>	
	1600lm	55°	21	<b>1003895</b>	
2700K	1600lm	20°	20	<b>1003842</b>	
	1600lm	40°	19	<b>1003845</b>	
	1600lm	55°	20	<b>1003848</b>	
3000K	1600lm	20°	20	<b>1003866</b>	
	1600lm	40°	20	<b>1003869</b>	
	1600lm	55°	21	<b>1003872</b>	
4000K	1750lm	20°	20	<b>1003890</b>	
	1750lm	40°	20	<b>1003893</b>	
	1750lm	55°	21	<b>1003896</b>	
2700K	1550lm	20°	17	<b>1003843</b>	
	1550lm	40°	17	<b>1003846</b>	
	1550lm	55°	18	<b>1003849</b>	
3000K	1550lm	20°	17	<b>1003867</b>	
	1550lm	40°	17	<b>1003870</b>	
	1550lm	55°	19	<b>1003873</b>	
4000K	1660lm	20°	17	<b>1003891</b>	
	1660lm	40°	17	<b>1003894</b>	
	1660lm	55°	19	<b>1003897</b>	
2700K	1460lm	20°	19	<b>1003853</b>	
	1460lm	40°	20	<b>1003856</b>	
	1460lm	55°	21	<b>1003859</b>	
3000K	1500lm	20°	19	<b>1003877</b>	
	1500lm	40°	20	<b>1003880</b>	
	1500lm	55°	21	<b>1003883</b>	
4000K	1600lm	20°	19	<b>1003901</b>	
	1600lm	40°	20	<b>1003904</b>	
	1600lm	55°	21	<b>1003907</b>	
2700K	1600lm	20°	20	<b>1003854</b>	
	1600lm	40°	19	<b>1003857</b>	
	1600lm	55°	20	<b>1003860</b>	
3000K	1600lm	20°	20	<b>1003878</b>	
	1600lm	40°	20	<b>1003881</b>	
	1600lm	55°	21	<b>1003884</b>	
4000K	1750lm	20°	20	<b>1003902</b>	
	1750lm	40°	20	<b>1003905</b>	
	1750lm	55°	21	<b>1003908</b>	
2700K	1550lm	20°	17	<b>1003855</b>	
	1550lm	40°	17	<b>1003858</b>	
	1550lm	55°	18	<b>1003861</b>	
3000K	1550lm	20°	17	<b>1003879</b>	
	1550lm	40°	17	<b>1003882</b>	
	1550lm	55°	19	<b>1003885</b>	
4000K	1660lm	20°	17	<b>1003903</b>	
	1660lm	40°	17	<b>1003906</b>	
	1660lm	55°	19	<b>1003909</b>	

# NUMINOS® L



## DL



**Product details:**

700mA  
 Premium LED with CRI>90  
 Power consumption: 25.4W  
 Material: aluminium/polycarbonate (PC)  
 Installation dimensions: Diameter: 11.7 cm D: 9 cm

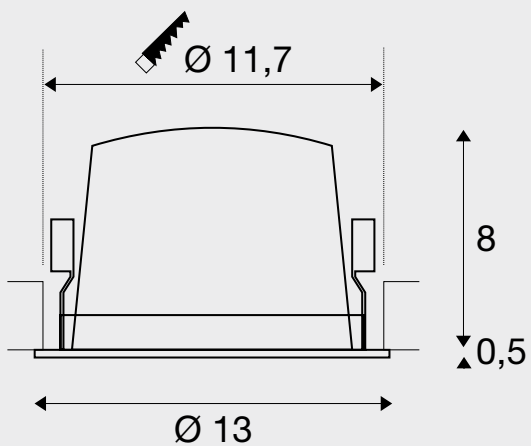

**Tip:**

Low-voltage plug  
 Driver not included

You can find suitable drivers and diffusers on pages 42-43.



black

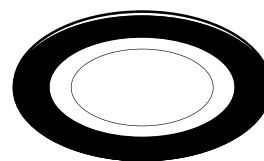

black



white



chrome



black

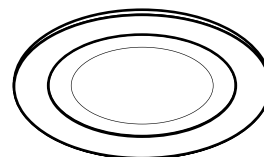

white



white



chrome





ITEM NO.

2700K	2150lm	20°	20	<b>1003913</b>			
	2150lm	40°	20	<b>1003916</b>			
	2150lm	55°	22	<b>1003919</b>			
3000K	2150lm	20°	20	<b>1003937</b>			
	2150lm	40°	21	<b>1003940</b>			
	2150lm	55°	23	<b>1003943</b>			
4000K	2350lm	20°	20	<b>1003961</b>			
	2350lm	40°	21	<b>1003964</b>			
	2350lm	55°	23	<b>1003967</b>			
2700K	2250lm	20°	18	<b>1003914</b>			
	2250lm	40°	18	<b>1003917</b>			
	2250lm	55°	20	<b>1003920</b>			
3000K	2300lm	20°	18	<b>1003938</b>			
	2300lm	40°	19	<b>1003941</b>			
	2300lm	55°	20	<b>1003944</b>			
4000K	2450lm	20°	18	<b>1003962</b>			
	2450lm	40°	19	<b>1003965</b>			
	2450lm	55°	20	<b>1003968</b>			
2700K	2150lm	20°	17	<b>1003915</b>			
	2150lm	40°	17	<b>1003918</b>			
	2150lm	55°	19	<b>1003921</b>			
3000K	2200lm	20°	17	<b>1003939</b>			
	2200lm	40°	18	<b>1003942</b>			
	2200lm	55°	19	<b>1003945</b>			
4000K	2350lm	20°	17	<b>1003963</b>			
	2350lm	40°	18	<b>1003966</b>			
	2350lm	55°	19	<b>1003969</b>			
2700K	2150lm	20°	20	<b>1003925</b>			
	2150lm	40°	20	<b>1003928</b>			
	2150lm	55°	22	<b>1003931</b>			
3000K	2150lm	20°	20	<b>1003949</b>			
	2150lm	40°	21	<b>1003952</b>			
	2150lm	55°	23	<b>1003955</b>			
4000K	2350lm	20°	20	<b>1003973</b>			
	2350lm	40°	21	<b>1003976</b>			
	2350lm	55°	23	<b>1003979</b>			
2700K	2250lm	20°	18	<b>1003926</b>			
	2250lm	40°	18	<b>1003929</b>			
	2250lm	55°	20	<b>1003932</b>			
3000K	2300lm	20°	18	<b>1003950</b>			
	2300lm	40°	19	<b>1003953</b>			
	2300lm	55°	20	<b>1003956</b>			
4000K	2450lm	20°	18	<b>1003974</b>			
	2450lm	40°	19	<b>1003977</b>			
	2450lm	55°	20	<b>1003980</b>			
2700K	2150lm	20°	17	<b>1003927</b>			
	2150lm	40°	17	<b>1003930</b>			
	2150lm	55°	19	<b>1003933</b>			
3000K	2200lm	20°	17	<b>1003951</b>			
	2200lm	40°	18	<b>1003954</b>			
	2200lm	55°	19	<b>1003957</b>			
4000K	2350lm	20°	17	<b>1003975</b>			
	2350lm	40°	18	<b>1003978</b>			
	2350lm	55°	19	<b>1003981</b>			

# NUMINOS® XL



## DL

**XL**



**Product details:**

1050mA  
 Premium LED with CRI>90  
 Power consumption: 37.4W  
 Material: aluminium/polycarbonate (PC)  
 Installation dimensions: Diameter: 14.5 cm D: 11.5 cm

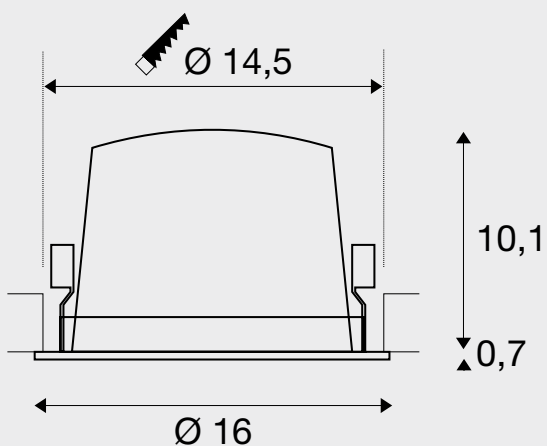
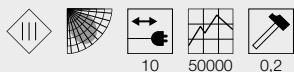

**Tip:**

Low-voltage plug  
 Driver not included

You can find suitable drivers and diffusers on pages 42-43.



black

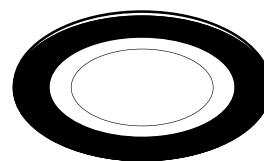

black



white



chrome



black

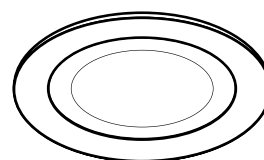

white



white



chrome



ITEM NO.

2700K	3300lm	20°	21	<b>1003985</b>				
	3300lm	40°	21	<b>1003988</b>				
	3300lm	55°	22	<b>1003991</b>				
3000K	3300lm	20°	21	<b>1004009</b>				
	3300lm	40°	21	<b>1004012</b>				
	3300lm	55°	22	<b>1004015</b>				
4000K	3600lm	20°	21	<b>1004033</b>				
	3600lm	40°	21	<b>1004036</b>				
	3600lm	55°	23	<b>1004039</b>				
2700K	3500lm	20°	18	<b>1003986</b>				
	3500lm	40°	18	<b>1003989</b>				
	3500lm	55°	19	<b>1003992</b>				
3000K	3550lm	20°	18	<b>1004010</b>				
	3550lm	40°	18	<b>1004013</b>				
	3550lm	55°	19	<b>1004016</b>				
4000K	3800lm	20°	18	<b>1004034</b>				
	3800lm	40°	18	<b>1004037</b>				
	3800lm	55°	19	<b>1004040</b>				
2700K	3400lm	20°	17	<b>1003987</b>				
	3400lm	40°	18	<b>1003990</b>				
	3400lm	55°	19	<b>1003993</b>				
3000K	3500lm	20°	17	<b>1004011</b>				
	3500lm	40°	18	<b>1004014</b>				
	3500lm	55°	19	<b>1004017</b>				
4000K	3750lm	20°	18	<b>1004035</b>				
	3750lm	40°	18	<b>1004038</b>				
	3750lm	55°	19	<b>1004041</b>				
2700K	3300lm	20°	21	<b>1003997</b>				
	3300lm	40°	21	<b>1004000</b>				
	3300lm	55°	22	<b>1004003</b>				
3000K	3300lm	20°	21	<b>1004021</b>				
	3300lm	40°	21	<b>1004024</b>				
	3300lm	55°	22	<b>1004027</b>				
4000K	3600lm	20°	21	<b>1004045</b>				
	3600lm	40°	21	<b>1004048</b>				
	3600lm	55°	23	<b>1004051</b>				
2700K	3500lm	20°	18	<b>1003998</b>				
	3500lm	40°	18	<b>1004001</b>				
	3500lm	55°	19	<b>1004004</b>				
3000K	3550lm	20°	18	<b>1004022</b>				
	3550lm	40°	18	<b>1004025</b>				
	3550lm	55°	19	<b>1004028</b>				
4000K	3800lm	20°	18	<b>1004046</b>				
	3800lm	40°	18	<b>1004049</b>				
	3800lm	55°	19	<b>1004052</b>				
2700K	3400lm	20°	17	<b>1003999</b>				
	3400lm	40°	18	<b>1004002</b>				
	3400lm	55°	19	<b>1004005</b>				
3000K	3500lm	20°	17	<b>1004023</b>				
	3500lm	40°	18	<b>1004026</b>				
	3500lm	55°	19	<b>1004029</b>				
4000K	3750lm	20°	18	<b>1004047</b>				
	3750lm	40°	18	<b>1004050</b>				
	3750lm	55°	19	<b>1004053</b>				

# NUMINOS® MOVE M



## DL



**Product details:**

500mA  
 Premium LED with CRI>90  
 Power consumption: 17.5W  
 Material: aluminium/polycarbonate (PC)  
 Installation dimensions: Diameter: 12 cm D: 10 cm

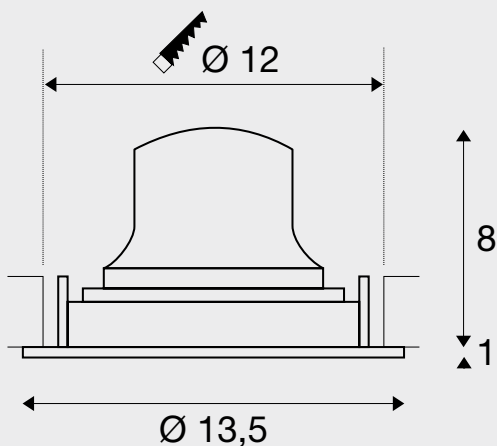
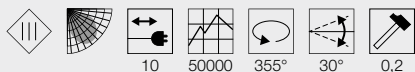

**Tip:**

Low-voltage plug  
 Driver not included

You can find suitable drivers and diffusers on pages 42-43.



black

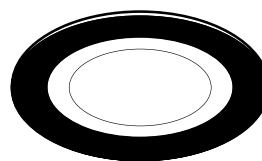

black



white



chrome



black

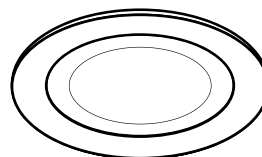

white



white

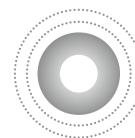

chrome



ITEM NO.

2700K	1460lm	20°	19	<b>1003553</b>			
	1460lm	40°	20	<b>1003556</b>			
	1460lm	55°	21	<b>1003559</b>			
3000K	1500lm	20°	19	<b>1003577</b>			
	1500lm	40°	20	<b>1003580</b>			
	1500lm	55°	21	<b>1003583</b>			
4000K	1600lm	20°	19	<b>1003601</b>			
	1600lm	40°	20	<b>1003604</b>			
	1600lm	55°	21	<b>1003607</b>			
2700K	1600lm	20°	20	<b>1003554</b>			
	1600lm	40°	19	<b>1003557</b>			
	1600lm	55°	20	<b>1003560</b>			
3000K	1600lm	20°	20	<b>1003578</b>			
	1600lm	40°	20	<b>1003581</b>			
	1600lm	55°	21	<b>1003584</b>			
4000K	1750lm	20°	20	<b>1003602</b>			
	1750lm	40°	20	<b>1003605</b>			
	1750lm	55°	21	<b>1003608</b>			
2700K	1550lm	20°	17	<b>1003555</b>			
	1550lm	40°	17	<b>1003558</b>			
	1550lm	55°	18	<b>1003561</b>			
3000K	1550lm	20°	17	<b>1003579</b>			
	1550lm	40°	17	<b>1003582</b>			
	1550lm	55°	19	<b>1003585</b>			
4000K	1660lm	20°	17	<b>1003603</b>			
	1660lm	40°	17	<b>1003606</b>			
	1660lm	55°	19	<b>1003609</b>			
2700K	1460lm	20°	19	<b>1003565</b>			
	1460lm	40°	20	<b>1003568</b>			
	1460lm	55°	21	<b>1003571</b>			
3000K	1500lm	20°	19	<b>1003589</b>			
	1500lm	40°	20	<b>1003592</b>			
	1500lm	55°	21	<b>1003595</b>			
4000K	1600lm	20°	19	<b>1003613</b>			
	1600lm	40°	20	<b>1003616</b>			
	1600lm	55°	21	<b>1003619</b>			
2700K	1600lm	20°	20	<b>1003566</b>			
	1600lm	40°	19	<b>1003569</b>			
	1600lm	55°	20	<b>1003572</b>			
3000K	1600lm	20°	20	<b>1003590</b>			
	1600lm	40°	20	<b>1003593</b>			
	1600lm	55°	21	<b>1003596</b>			
4000K	1750lm	20°	20	<b>1003614</b>			
	1750lm	40°	20	<b>1003617</b>			
	1750lm	55°	21	<b>1003620</b>			
2700K	1550lm	20°	17	<b>1003567</b>			
	1550lm	40°	17	<b>1003570</b>			
	1550lm	55°	18	<b>1003573</b>			
3000K	1550lm	20°	17	<b>1003591</b>			
	1550lm	40°	17	<b>1003594</b>			
	1550lm	55°	19	<b>1003597</b>			
4000K	1660lm	20°	17	<b>1003615</b>			
	1660lm	40°	17	<b>1003618</b>			
	1660lm	55°	19	<b>1003621</b>			

# NUMINOS® MOVE L



## DL



**Product details:**

750mA  
 Premium LED with CRI>90  
 Power consumption: 25.4W  
 Material: aluminium/polycarbonate (PC)  
 Installation dimensions: Diameter: 14.5 cm D: 10.5 cm

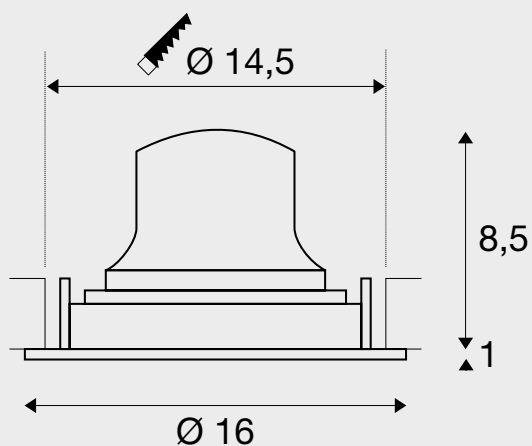
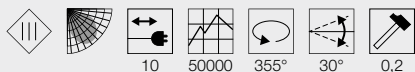

**Tip:**

Low-voltage plug  
 Driver not included

You can find suitable drivers and diffusers on pages 42-43.



black

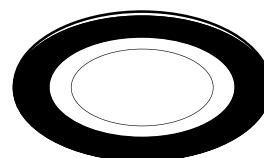

black



white

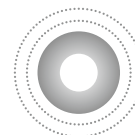

chrome



black

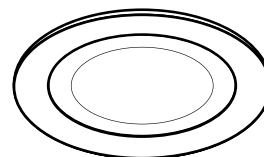

white



white

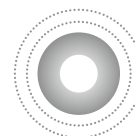

chrome

					ITEM NO.	
2700K		2150lm	20°	20	<b>1003625</b>	
		2150lm	40°	20	<b>1003628</b>	
		2150lm	55°	22	<b>1003631</b>	
3000K		2150lm	20°	20	<b>1003649</b>	
		2150lm	40°	21	<b>1003652</b>	
		2150lm	55°	23	<b>1003655</b>	
4000K		2350lm	20°	20	<b>1003673</b>	
		2350lm	40°	21	<b>1003676</b>	
		2350lm	55°	23	<b>1003679</b>	
2700K		2250lm	20°	18	<b>1003626</b>	
		2250lm	40°	18	<b>1003629</b>	
		2250lm	55°	20	<b>1003632</b>	
3000K		2300lm	20°	18	<b>1003650</b>	
		2300lm	40°	19	<b>1003653</b>	
		2300lm	55°	20	<b>1003656</b>	
4000K		2450lm	20°	18	<b>1003674</b>	
		2450lm	40°	19	<b>1003677</b>	
		2450lm	55°	20	<b>1003680</b>	
2700K		2150lm	20°	17	<b>1003627</b>	
		2150lm	40°	17	<b>1003630</b>	
		2150lm	55°	19	<b>1003633</b>	
3000K		2200lm	20°	17	<b>1003651</b>	
		2200lm	40°	18	<b>1003654</b>	
		2200lm	55°	19	<b>1003657</b>	
4000K		2350lm	20°	17	<b>1003675</b>	
		2350lm	40°	18	<b>1003678</b>	
		2350lm	55°	19	<b>1003681</b>	
2700K		2150lm	20°	20	<b>1003637</b>	
		2150lm	40°	20	<b>1003640</b>	
		2150lm	55°	22	<b>1003643</b>	
3000K		2150lm	20°	20	<b>1003661</b>	
		2150lm	40°	21	<b>1003664</b>	
		2150lm	55°	23	<b>1003667</b>	
4000K		2350lm	20°	20	<b>1003685</b>	
		2350lm	40°	21	<b>1003688</b>	
		2350lm	55°	23	<b>1003691</b>	
2700K		2250lm	20°	18	<b>1003638</b>	
		2250lm	40°	18	<b>1003641</b>	
		2250lm	55°	20	<b>1003644</b>	
3000K		2300lm	20°	18	<b>1003662</b>	
		2300lm	40°	19	<b>1003665</b>	
		2300lm	55°	20	<b>1003668</b>	
4000K		2450lm	20°	18	<b>1003686</b>	
		2450lm	40°	19	<b>1003689</b>	
		2450lm	55°	20	<b>1003692</b>	
2700K		2150lm	20°	17	<b>1003639</b>	
		2150lm	40°	17	<b>1003642</b>	
		2150lm	55°	19	<b>1003645</b>	
3000K		2200lm	20°	17	<b>1003663</b>	
		2200lm	40°	18	<b>1003666</b>	
		2200lm	55°	19	<b>1003669</b>	
4000K		2350lm	20°	17	<b>1003687</b>	
		2350lm	40°	18	<b>1003690</b>	
		2350lm	55°	19	<b>1003693</b>	

# NUMINOS® MOVE XL



## DL

**XL**



**Product details:**

1050mA  
 Premium LED with CRI>90  
 Power consumption: 37.4W  
 Material: aluminium/polycarbonate (PC)  
 Installation dimensions: Diameter: 17.5 cm D: 13 cm

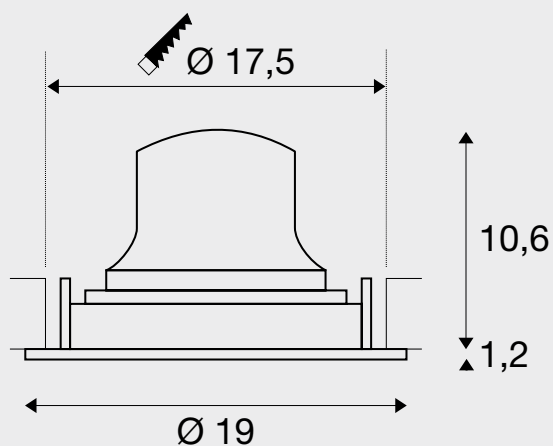
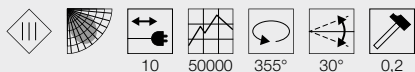

**Tip:**

Low-voltage plug  
 Driver not included

You can find suitable drivers and diffusers on pages 42-43.



black

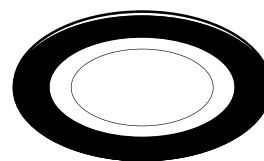

black



white



chrome



black

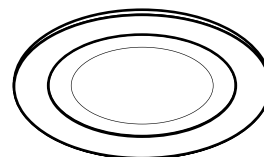

white



white



chrome

















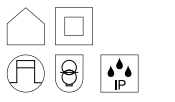
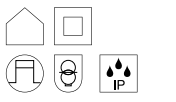
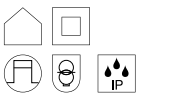
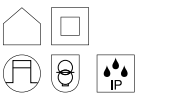
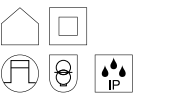
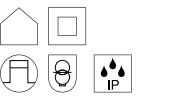

ITEM NO.

2700K	3300lm	20°	21	<b>1003697</b>				
	3300lm	40°	21	<b>1003700</b>				
	3300lm	55°	22	<b>1003703</b>				
3000K	3300lm	20°	21	<b>1003721</b>				
	3300lm	40°	21	<b>1003724</b>				
	3300lm	55°	22	<b>1003727</b>				
4000K	3600lm	20°	21	<b>1003745</b>				
	3600lm	40°	21	<b>1003748</b>				
	3600lm	55°	23	<b>1003751</b>				
2700K	3500lm	20°	18	<b>1003698</b>				
	3500lm	40°	18	<b>1003701</b>				
	3500lm	55°	19	<b>1003704</b>				
3000K	3550lm	20°	18	<b>1003722</b>				
	3550lm	40°	18	<b>1003725</b>				
	3550lm	55°	19	<b>1003728</b>				
4000K	3800lm	20°	18	<b>1003746</b>				
	3800lm	40°	18	<b>1003749</b>				
	3800lm	55°	19	<b>1003752</b>				
2700K	3400lm	20°	17	<b>1003699</b>				
	3400lm	40°	18	<b>1003702</b>				
	3400lm	55°	19	<b>1003705</b>				
3000K	3500lm	20°	17	<b>1003723</b>				
	3500lm	40°	18	<b>1003726</b>				
	3500lm	55°	19	<b>1003729</b>				
4000K	3750lm	20°	18	<b>1003747</b>				
	3750lm	40°	18	<b>1003750</b>				
	3750lm	55°	19	<b>1003753</b>				
2700K	3300lm	20°	21	<b>1003709</b>				
	3300lm	40°	21	<b>1003712</b>				
	3300lm	55°	22	<b>1003715</b>				
3000K	3300lm	20°	21	<b>1003733</b>				
	3300lm	40°	21	<b>1003736</b>				
	3300lm	55°	22	<b>1003739</b>				
4000K	3600lm	20°	21	<b>1003757</b>				
	3600lm	40°	21	<b>1003760</b>				
	3600lm	55°	23	<b>1003763</b>				
2700K	3500lm	20°	18	<b>1003710</b>				
	3500lm	40°	18	<b>1003713</b>				
	3500lm	55°	19	<b>1003716</b>				
3000K	3550lm	20°	18	<b>1003734</b>				
	3550lm	40°	18	<b>1003737</b>				
	3550lm	55°	19	<b>1003740</b>				
4000K	3800lm	20°	18	<b>1003758</b>				
	3800lm	40°	18	<b>1003761</b>				
	3800lm	55°	19	<b>1003764</b>				
2700K	3400lm	20°	17	<b>1003711</b>				
	3400lm	40°	18	<b>1003714</b>				
	3400lm	55°	19	<b>1003717</b>				
3000K	3500lm	20°	17	<b>1003735</b>				
	3500lm	40°	18	<b>1003738</b>				
	3500lm	55°	19	<b>1003741</b>				
4000K	3750lm	20°	18	<b>1003759</b>				
	3750lm	40°	18	<b>1003762</b>				
	3750lm	55°	19	<b>1003765</b>				

# Accessory

## Perfect driver assignment

						
	<b>S</b>	<b>S</b>	<b>S</b>	<b>M</b>	<b>M</b>	<b>M</b>
						
	250mA	250mA	250/350/500/700mA	500/600/700mA	500mA	250/350/500/700mA
<b>Material</b>	Polycarbonate (PC)	Polycarbonate (PC)	Polycarbonate (PC)	Polycarbonate (PC)	Polycarbonate (PC)	Polycarbonate (PC)
<b>Colour</b>	white	white	white	white	white	white
<b>Voltage prim.</b>	220-240V ~50/60Hz	220-240V ~50/60Hz	220-240V ~50/60Hz	220-240V ~50/60Hz	220-240V ~50/60Hz	220-240V ~50/60Hz
<b>Voltage sec.</b>	26-40V	30-42V	6-60V	30-42V	42-60V	6-58V
<b>Output current</b>	250mA	250mA	250/350/500/700mA	500/600/700mA	500mA	250/350/500/700mA
<b>Number of outputs sec.</b>	1	1	1	1	1	1
<b>Output from</b>	6.5W	7.5W	1.5W	15W	21W	1.5W
<b>Output up to</b>	10W	10W	15W	29.5W	30W	40.6W
<b>Environmental temp. min.</b>	-20°C	-20°C	-20°C	-20°C	-25°C	-25°C
<b>Environmental temp. max.</b>	45°C	50°C	50°C	50°C	50°C	50°C
<b>Temperature protection</b>	110°C	110°C	110°C	110°C	110°C	110°C
<b>IP protection rating</b>	IP 20	IP 20	IP 20	IP 20	IP 20	IP 20
<b>Dimmable</b>	-	PHASE C	DALI	-	PHASE C	DALI
<b>Length</b>	6.5 cm	8.5 cm	15 cm	14.7 cm	13.8 cm	12.3 cm
<b>Width</b>	3.9 cm	3.9 cm	5.2 cm	4.3 cm	4.4 cm	7.9 cm
<b>Height</b>	2 cm	2.2 cm	2.8 cm	3 cm	3 cm	2.4 cm
<b>Weight</b>	0.05 kg	0.05 kg	0.142 kg	0.105 kg	0.13 kg	1.21 kg
<b>Item No.</b>	<b>1004058</b>	<b>1004055</b>	<b>1004067</b>	<b>1004064</b>	<b>1004054</b>	<b>1004069</b>

	<b>S</b>				<b>M</b>			
								
	SL153 elliptical	SL154 prismatic	SL155 frosted	SL305 honeycomb	SL153A elliptical	SL154A prismatic	SL155A frosted	SL306 honeycomb
<b>Item No.</b>	<b>1004786</b>	<b>1004787</b>	<b>1004788</b>	<b>1004789</b>	<b>1004790</b>	<b>1004791</b>	<b>1004792</b>	<b>1004793</b>

	<b>L</b>	<b>L</b>	<b>L</b>	<b>XL</b>	<b>XL</b>	<b>XL</b>
	500/600/700mA	700mA	700mA	800/900/1050mA	1000mA	1050mA
<b>Material</b>	Polycarbonate (PC)	Polycarbonate (PC)	Polycarbonate (PC)	Polycarbonate (PC)	Polycarbonate (PC)	Polycarbonate (PC)
<b>Colour</b>	white	white	white	white	white	white
<b>Voltage prim.</b>	220-240V ~50/60Hz	220-240V ~50/60Hz	220-240V ~50/60Hz	220-240V ~50/60Hz	220-240V ~50/60Hz	220-240V ~50/60Hz
<b>Voltage sec.</b>	30-42V	30-42V	6-58V	30-42V	28-40V	6-58V
<b>Output current</b>	500/600/700mA	700mA	250/350/500/700mA	800/900/1050mA	1000mA	700/800/900/1050/1200/1300/1400mA
<b>Number of outputs sec.</b>	1	1	1	1	1	1
<b>Output from</b>	15W	21W	1.5W	24W	28W	4.2W
<b>Output up to</b>	29.5W	29.4W	40.6W	44W	40W	50W
<b>Environmental temp. min.</b>	-20°C	-20°C	-25°C	-20°C	-20°C	-25°C
<b>Environmental temp. max.</b>	50°C	50°C	50°C	50°C	50°C	50°C
<b>Temperature protection</b>	110°C	110°C	110°C	110°C	110°C	110°C
<b>IP protection rating</b>	IP 20	IP 20	IP 20	IP 20	IP 20	IP 20
<b>Dimmable</b>	-	PHASE C	DALI	-	PHASE C	DALI
<b>Length</b>	14.7 cm	11.5W	12.3 cm	9.7 cm	15.3 cm	12.3 cm
<b>Width</b>	4.3 cm	4.4 cm	7.9 cm	4.3 cm	6.7 cm	7.9 cm
<b>Height</b>	3 cm	3 cm	2.4 cm	3 cm	3 cm	2.4 cm
<b>Weight</b>	0.105 kg	0.072 kg	1.21 kg	0.072 kg	0.2 kg	0.215 kg
<b>Item No.</b>	<b>1004062</b>	<b>1004065</b>	<b>1004070</b>	<b>1004059</b>	<b>1004066</b>	<b>1004071</b>

	<b>L</b>					<b>XL</b>		
<b>Item No.</b>	<b>1004794</b>	<b>1004795</b>	<b>1004796</b>	<b>1004797</b>	<b>1004798</b>	<b>1004799</b>	<b>1004800</b>	<b>1004801</b>

# NUMINOS® S



## 3-circuit

**Product details:**

220-240V ~50/60Hz | 250mA  
 Premium LED with CRI>90  
 Total wattage: 10.42W  
 Material: aluminium/plastic

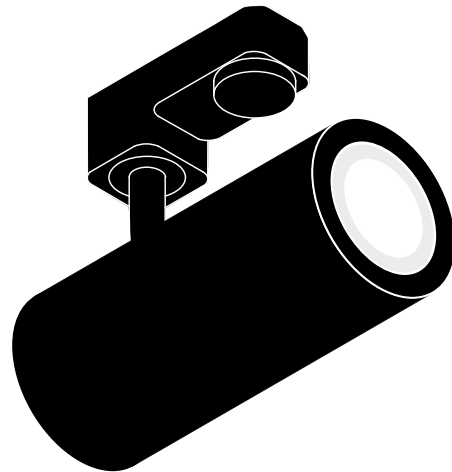
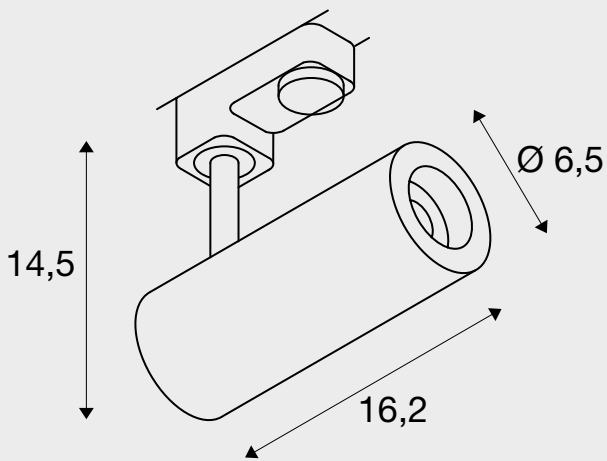

■ black

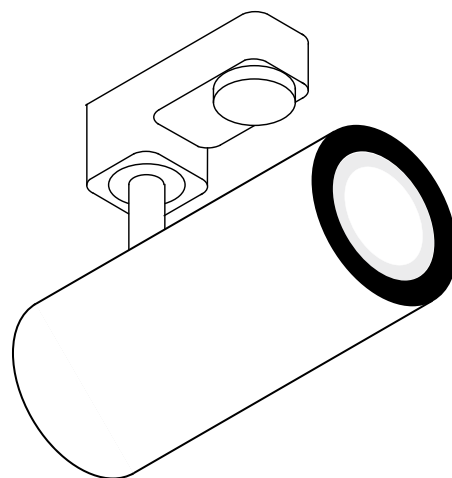

□ white



ITEM NO.

	2700K	985lm	24°	<b>1004074</b>
		985lm	36°	<b>1004075</b>
		980lm	60°	<b>1004076</b>
	3000K	1020lm	24°	<b>1004082</b>
		1020lm	36°	<b>1004083</b>
		1020lm	60°	<b>1004084</b>
	4000K	1100lm	24°	<b>1004090</b>
		1100lm	36°	<b>1004091</b>
		1100lm	60°	<b>1004092</b>



	2700K	985lm	24°	<b>1004362</b>
		985lm	36°	<b>1004363</b>
		980lm	60°	<b>1004364</b>
	3000K	1020lm	24°	<b>1004370</b>
		1020lm	36°	<b>1004371</b>
		1020lm	60°	<b>1004372</b>
	4000K	1100lm	24°	<b>1004378</b>
		1100lm	36°	<b>1004379</b>
		1100lm	60°	<b>1004380</b>



	2700K	980lm	24°	<b>1004078</b>
		985lm	36°	<b>1004079</b>
		980lm	60°	<b>1004080</b>
	3000K	1020lm	24°	<b>1004086</b>
		1020lm	36°	<b>1004087</b>
		1020lm	60°	<b>1004088</b>
	4000K	1090lm	24°	<b>1004094</b>
		1100lm	36°	<b>1004095</b>
		1090lm	60°	<b>1004096</b>



	2700K	985lm	24°	<b>1004366</b>
		985lm	36°	<b>1004367</b>
		980lm	60°	<b>1004368</b>
	3000K	1020lm	24°	<b>1004374</b>
		1020lm	36°	<b>1004375</b>
		1020lm	60°	<b>1004376</b>
	4000K	1100lm	24°	<b>1004382</b>
		1100lm	36°	<b>1004383</b>
		1100lm	60°	<b>1004384</b>



# NUMINOS® M



## 3-circuit

**Product details:**

220-240V ~50/60Hz | 500mA  
 Premium LED with CRI>90  
 Total wattage: 20.1W  
 Material: aluminium/plastic

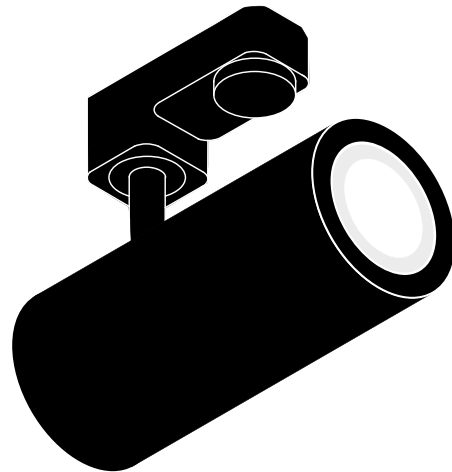
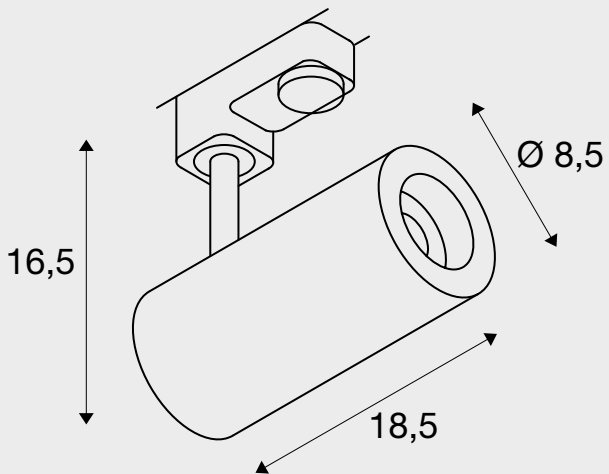

■ black

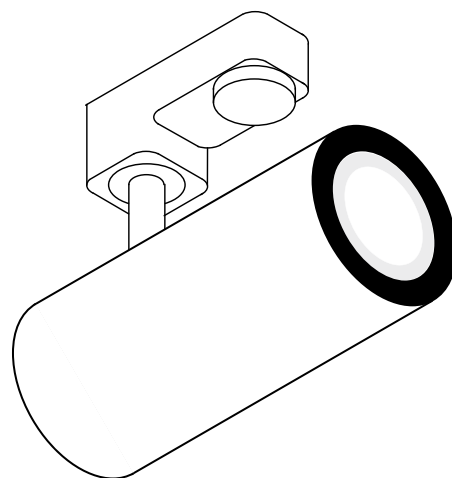

□ white



ITEM NO.

	2700K	1925lm	24°	<b>1004170</b>
		1935lm	36°	<b>1004171</b>
		1885lm	60°	<b>1004172</b>
	3000K	1955lm	24°	<b>1004178</b>
		1970lm	36°	<b>1004179</b>
		1880lm	60°	<b>1004180</b>
	4000K	2125lm	24°	<b>1004186</b>
		2120lm	36°	<b>1004187</b>
		2060lm	60°	<b>1004188</b>



	2700K	1925lm	24°	<b>1004458</b>
		1935lm	36°	<b>1004459</b>
		1885lm	60°	<b>1004460</b>
	3000K	1930lm	24°	<b>1004466</b>
		1970lm	36°	<b>1004467</b>
		1880lm	60°	<b>1004468</b>
	4000K	2125lm	24°	<b>1004474</b>
		2120lm	36°	<b>1004475</b>
		2060lm	60°	<b>1004476</b>



	2700K	1925lm	24°	<b>1004174</b>
		1935lm	36°	<b>1004175</b>
		1870lm	60°	<b>1004176</b>
	3000K	1955lm	24°	<b>1004182</b>
		1970lm	36°	<b>1004183</b>
		1870lm	60°	<b>1004184</b>
	4000K	2125lm	24°	<b>1004190</b>
		2120lm	36°	<b>1004191</b>
		2060lm	60°	<b>1004192</b>



	2700K	1925lm	24°	<b>1004462</b>
		1935lm	36°	<b>1004463</b>
		1885lm	60°	<b>1004464</b>
	3000K	1955lm	24°	<b>1004470</b>
		1970lm	36°	<b>1004471</b>
		1880lm	60°	<b>1004472</b>
	4000K	2125lm	24°	<b>1004478</b>
		2120lm	36°	<b>1004479</b>
		2060lm	60°	<b>1004480</b>



# NUMINOS® L



## 3-circuit

**Product details:**

220-240V ~50/60Hz | 700mA  
 Premium LED with CRI>90  
 System output: 28W  
 Material: aluminium/plastic

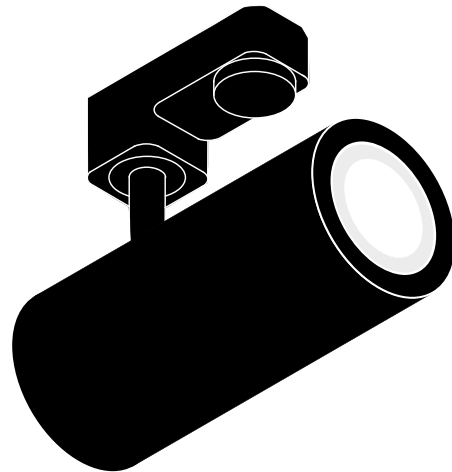
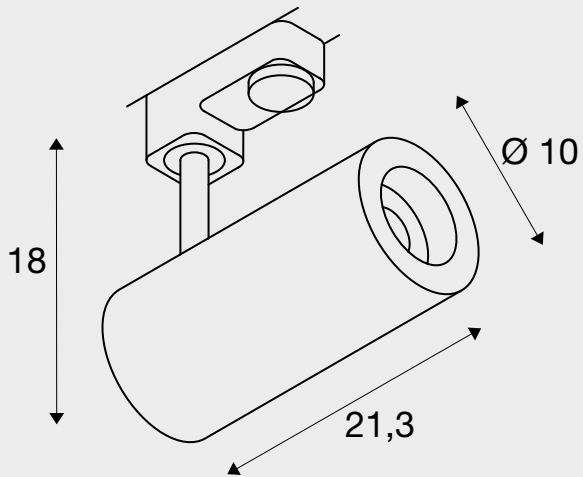

■ black

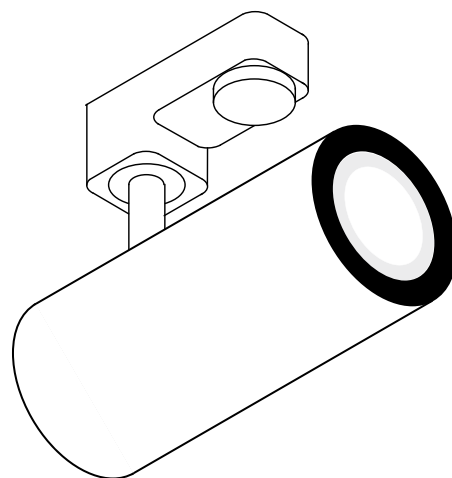

□ white





ITEM NO.

	2700K	2440lm	24°	<b>1004266</b>
		2400lm	36°	<b>1004267</b>
		2475lm	60°	<b>1004268</b>
	3000K	2430lm	24°	<b>1004274</b>
		2340lm	36°	<b>1004275</b>
		2400lm	60°	<b>1004276</b>
	4000K	2675lm	24°	<b>1004282</b>
		2620lm	36°	<b>1004283</b>
		2715lm	60°	<b>1004284</b>



	2700K	2430lm	24°	<b>1004554</b>
		2400lm	36°	<b>1004555</b>
		2475lm	60°	<b>1004556</b>
	3000K	2430lm	24°	<b>1004562</b>
		2340lm	36°	<b>1004563</b>
		2400lm	60°	<b>1004564</b>
	4000K	2675lm	24°	<b>1004570</b>
		2620lm	36°	<b>1004571</b>
		2715lm	60°	<b>1004572</b>



	2700K	2430lm	24°	<b>1004270</b>
		2400lm	36°	<b>1004271</b>
		2475lm	60°	<b>1004272</b>
	3000K	2430lm	24°	<b>1004278</b>
		2340lm	36°	<b>1004279</b>
		2400lm	60°	<b>1004280</b>
	4000K	2675lm	24°	<b>1004286</b>
		2620lm	36°	<b>1004287</b>
		2715lm	60°	<b>1004288</b>



	2700K	2440lm	24°	<b>1004558</b>
		2400lm	36°	<b>1004559</b>
		2475lm	60°	<b>1004560</b>
	3000K	2430lm	24°	<b>1004566</b>
		2340lm	36°	<b>1004567</b>
		2400lm	60°	<b>1004568</b>
	4000K	2675lm	24°	<b>1004574</b>
		2620lm	36°	<b>1004575</b>
		2715lm	60°	<b>1004576</b>



# NUMINOS® S



## CW

**Product details:**

220-240V ~50/60Hz | 250mA  
 Premium LED with CRI>90  
 Total wattage: 10.42W  
 Material: aluminium/plastic

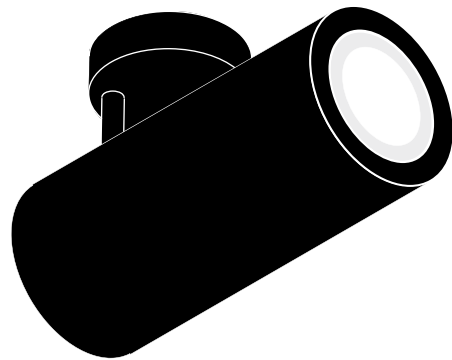
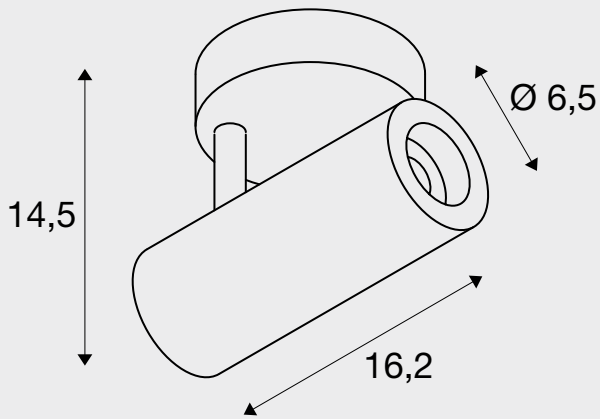

■ black

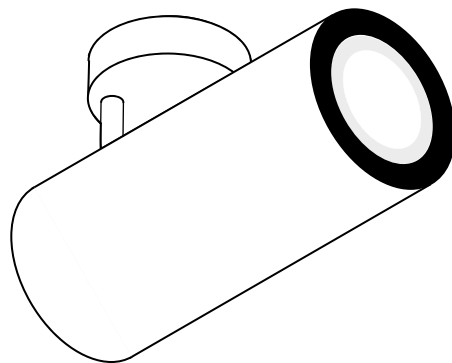

□ white



ITEM NO.

	2700K	985lm	24°	<b>1004098</b>
		985lm	36°	<b>1004099</b>
		980lm	60°	<b>1004100</b>
	3000K	1020lm	24°	<b>1004106</b>
		1020lm	36°	<b>1004107</b>
		1020lm	60°	<b>1004108</b>
	4000K	1100lm	24°	<b>1004114</b>
		1100lm	36°	<b>1004115</b>
		1100lm	60°	<b>1004116</b>



	2700K	985lm	24°	<b>1004386</b>
		980lm	36°	<b>1004387</b>
		980lm	60°	<b>1004388</b>
	3000K	1020lm	24°	<b>1004394</b>
		1020lm	36°	<b>1004395</b>
		1020lm	60°	<b>1004396</b>
	4000K	1090lm	24°	<b>1004402</b>
		1100lm	36°	<b>1004403</b>
		1100lm	60°	<b>1004404</b>



	2700K	985lm	24°	<b>1004102</b>
		985lm	36°	<b>1004103</b>
		980lm	60°	<b>1004104</b>
	3000K	1020lm	24°	<b>1004110</b>
		1020lm	36°	<b>1004111</b>
		1020lm	60°	<b>1004112</b>
	4000K	1100lm	24°	<b>1004118</b>
		1100lm	36°	<b>1004119</b>
		1090lm	60°	<b>1004120</b>



	2700K	985lm	24°	<b>1004390</b>
		985lm	36°	<b>1004391</b>
		980lm	60°	<b>1004392</b>
	3000K	1020lm	24°	<b>1004398</b>
		1020lm	36°	<b>1004399</b>
		1020lm	60°	<b>1004400</b>
	4000K	1090lm	24°	<b>1004406</b>
		1100lm	36°	<b>1004407</b>
		1100lm	60°	<b>1004408</b>



# NUMINOS® M



## CL

**Product details:**

220-240V ~50/60Hz | 500mA  
Premium LED with CRI>90  
Total wattage: 20.1W  
Material: aluminium/plastic

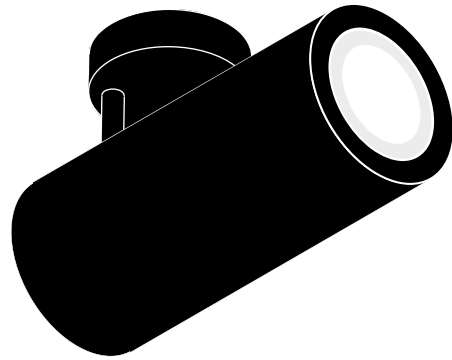
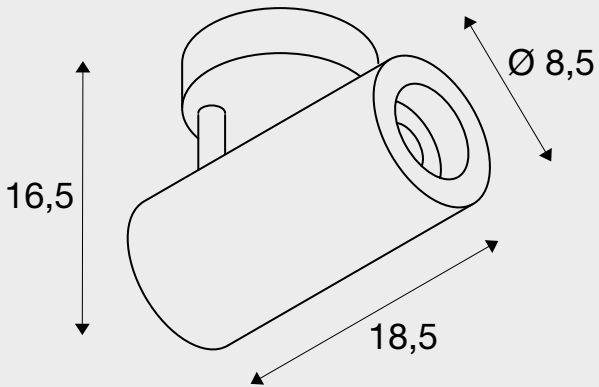

■ black

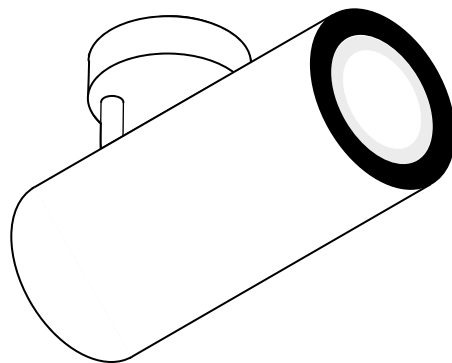

□ white



ITEM NO.

	2700K	1925lm	24°	<b>1004194</b>
		1935lm	36°	<b>1004195</b>
		1870lm	60°	<b>1004196</b>
	3000K	1955lm	24°	<b>1004202</b>
		1950lm	36°	<b>1004203</b>
		1870lm	60°	<b>1004204</b>
	4000K	2125lm	24°	<b>1004210</b>
		2120lm	36°	<b>1004211</b>
		2060lm	60°	<b>1004212</b>



	2700K	1925lm	24°	<b>1004482</b>
		1935lm	36°	<b>1004483</b>
		1885lm	60°	<b>1004484</b>
	3000K	1955lm	24°	<b>1004490</b>
		1950lm	36°	<b>1004491</b>
		1880lm	60°	<b>1004492</b>
	4000K	2125lm	24°	<b>1004498</b>
		2120lm	36°	<b>1004499</b>
		2060lm	60°	<b>1004500</b>



	2700K	1930lm	24°	<b>1004198</b>
		1930lm	36°	<b>1004199</b>
		1885lm	60°	<b>1004200</b>
	3000K	1955lm	24°	<b>1004206</b>
		1970lm	36°	<b>1004207</b>
		1880lm	60°	<b>1004208</b>
	4000K	2125lm	24°	<b>1004214</b>
		2120lm	36°	<b>1004215</b>
		2060lm	60°	<b>1004216</b>



	2700K	1925lm	24°	<b>1004486</b>
		1935lm	36°	<b>1004487</b>
		1885lm	60°	<b>1004488</b>
	3000K	1930lm	24°	<b>1004494</b>
		1970lm	36°	<b>1004495</b>
		1880lm	60°	<b>1004496</b>
	4000K	2120lm	24°	<b>1004502</b>
		2120lm	36°	<b>1004503</b>
		2060lm	60°	<b>1004504</b>



# NUMINOS® L



## CL

**Product details:**

220-240V ~50/60Hz | 700mA  
Premium LED with CRI>90  
System output: 28W  
Material: aluminium/plastic



50000

350°

90°

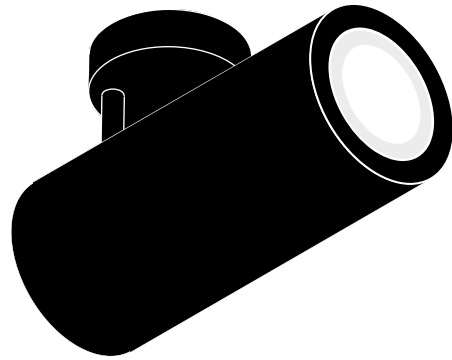
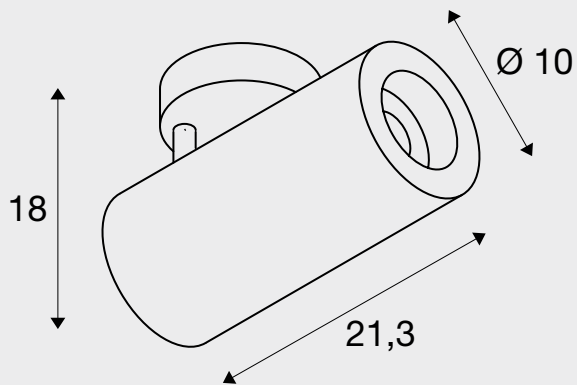

■ black

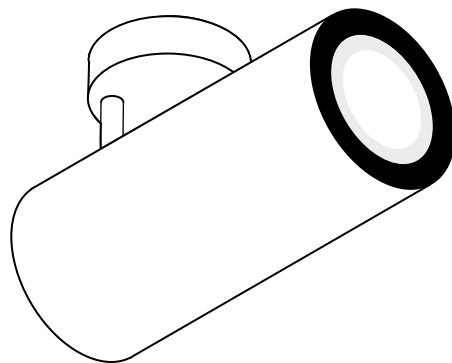

□ white



ITEM NO.

	2700K	2440lm	24°	<b>1004290</b>
		2400lm	36°	<b>1004291</b>
		2475lm	60°	<b>1004292</b>
	3000K	2430lm	24°	<b>1004298</b>
		2340lm	36°	<b>1004299</b>
		2400lm	60°	<b>1004300</b>
	4000K	2675lm	24°	<b>1004306</b>
		2620lm	36°	<b>1004307</b>
		2715lm	60°	<b>1004308</b>



	2700K	2440lm	24°	<b>1004578</b>
		2400lm	36°	<b>1004579</b>
		2475lm	60°	<b>1004580</b>
	3000K	2430lm	24°	<b>1004586</b>
		2340lm	36°	<b>1004587</b>
		2400lm	60°	<b>1004588</b>
	4000K	2675lm	24°	<b>1004594</b>
		2620lm	36°	<b>1004595</b>
		2715lm	60°	<b>1004596</b>



	2700K	2430lm	24°	<b>1004294</b>
		2400lm	36°	<b>1004295</b>
		2475lm	60°	<b>1004296</b>
	3000K	2430lm	24°	<b>1004302</b>
		2340lm	36°	<b>1004303</b>
		2400lm	60°	<b>1004304</b>
	4000K	2675lm	24°	<b>1004310</b>
		2620lm	36°	<b>1004311</b>
		2720lm	60°	<b>1004312</b>



	2700K	2440lm	24°	<b>1004582</b>
		2400lm	36°	<b>1004583</b>
		2475lm	60°	<b>1004584</b>
	3000K	2430lm	24°	<b>1004590</b>
		2340lm	36°	<b>1004591</b>
		2400lm	60°	<b>1004592</b>
	4000K	2675lm	24°	<b>1004598</b>
		2620lm	36°	<b>1004599</b>
		2715lm	60°	<b>1004600</b>



# NUMINOS® S



## CL

**Product details:**

220-240V ~50/60Hz | 250mA  
Premium LED with CRI>90  
Total wattage: 10.42W  
Material: aluminium/plastic

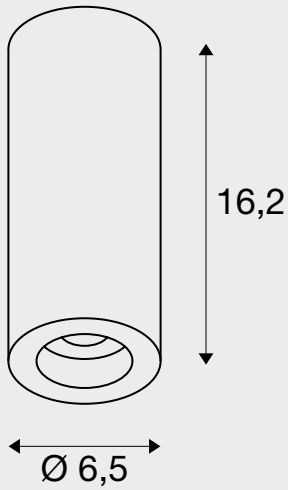

■ black



□ white





ITEM NO.

	2700K	985lm	24°	<b>1004122</b>	
		985lm	36°	<b>1004123</b>	
		980lm	60°	<b>1004124</b>	
	3000K	1020lm	24°	<b>1004130</b>	
		1020lm	36°	<b>1004131</b>	
		1020lm	60°	<b>1004132</b>	
	4000K	1100lm	24°	<b>1004138</b>	
		1100lm	36°	<b>1004139</b>	
		1100lm	60°	<b>1004140</b>	

	2700K	985lm	24°	<b>1004410</b>	
		985lm	36°	<b>1004411</b>	
		980lm	60°	<b>1004412</b>	
	3000K	1020lm	24°	<b>1004418</b>	
		1020lm	36°	<b>1004419</b>	
		1010lm	60°	<b>1004420</b>	
	4000K	1100lm	24°	<b>1004426</b>	
		1100lm	36°	<b>1004427</b>	
		1100lm	60°	<b>1004428</b>	

	2700K	980lm	24°	<b>1004126</b>	
		985lm	36°	<b>1004127</b>	
		980lm	60°	<b>1004128</b>	
	3000K	1010lm	24°	<b>1004134</b>	
		1020lm	36°	<b>1004135</b>	
		2620lm	60°	<b>1004136</b>	
	4000K	1100lm	24°	<b>1004142</b>	
		1100lm	36°	<b>1004143</b>	
		1090lm	60°	<b>1004144</b>	

	2700K	985lm	24°	<b>1004414</b>	
		980lm	36°	<b>1004415</b>	
		980lm	60°	<b>1004416</b>	
	3000K	1010lm	24°	<b>1004422</b>	
		1020lm	36°	<b>1004423</b>	
		1020lm	60°	<b>1004424</b>	
	4000K	1100lm	24°	<b>1004430</b>	
		1100lm	36°	<b>1004431</b>	
		1100lm	60°	<b>1004432</b>	

# NUMINOS® M



## CL

**Product details:**

220-240V ~50/60Hz | 500mA

Premium LED with CRI>90

Total wattage: 20.1W

Material: aluminium/plastic



50000

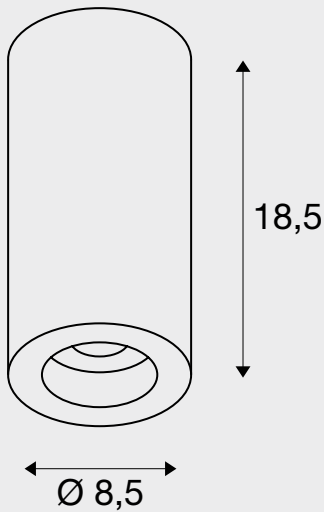

■ black



□ white



ITEM NO.

	2700K	1925lm	24°	<b>1004218</b>	
		1930lm	36°	<b>1004219</b>	
		1870lm	60°	<b>1004220</b>	
	3000K	1950lm	24°	<b>1004226</b>	
		1970lm	36°	<b>1004227</b>	
		1880lm	60°	<b>1004228</b>	
	4000K	2125lm	24°	<b>1004234</b>	
		2120lm	36°	<b>1004235</b>	
		2060lm	60°	<b>1004236</b>	

	2700K	1925lm	24°	<b>1004506</b>	
		1935lm	36°	<b>1004507</b>	
		1885lm	60°	<b>1004508</b>	
	3000K	1930lm	24°	<b>1004514</b>	
		1970lm	36°	<b>1004515</b>	
		1870lm	60°	<b>1004516</b>	
	4000K	2125lm	24°	<b>1004522</b>	
		2120lm	36°	<b>1004523</b>	
		2060lm	60°	<b>1004524</b>	

	2700K	1925lm	24°	<b>1004222</b>	
		1935lm	36°	<b>1004223</b>	
		1885lm	60°	<b>1004224</b>	
	3000K	1955lm	24°	<b>1004230</b>	
		1950lm	36°	<b>1004231</b>	
		1870lm	60°	<b>1004232</b>	
	4000K	2125lm	24°	<b>1004238</b>	
		2120lm	36°	<b>1004239</b>	
		2060lm	60°	<b>1004240</b>	

	2700K	1925lm	24°	<b>1004510</b>	
		1935lm	36°	<b>1004511</b>	
		1885lm	60°	<b>1004512</b>	
	3000K	1950lm	24°	<b>1004518</b>	
		1950lm	36°	<b>1004519</b>	
		1880lm	60°	<b>1004520</b>	
	4000K	2125lm	24°	<b>1004526</b>	
		2120lm	36°	<b>1004527</b>	
		2060lm	60°	<b>1004528</b>	

# NUMINOS® L



## CL

**Product details:**

220-240V ~50/60Hz | 700mA  
Premium LED with CRI>90  
System output: 28W  
Material: aluminium/plastic

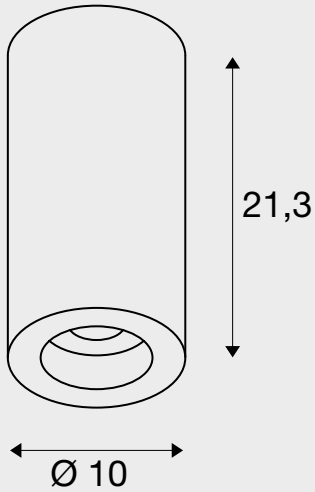

■ black



□ white



ITEM NO.

	2700K	2440lm	24°	<b>1004314</b>	
		2400lm	36°	<b>1004315</b>	
		2475lm	60°	<b>1004316</b>	
	3000K	2430lm	24°	<b>1004322</b>	
		2340lm	36°	<b>1004323</b>	
		2400lm	60°	<b>1004324</b>	
	4000K	2675lm	24°	<b>1004330</b>	
		2620lm	36°	<b>1004331</b>	
		2715lm	60°	<b>1004332</b>	

	2700K	2440lm	24°	<b>1004602</b>	
		2400lm	36°	<b>1004603</b>	
		2475lm	60°	<b>1004604</b>	
	3000K	2430lm	24°	<b>1004610</b>	
		2340lm	36°	<b>1004611</b>	
		2400lm	60°	<b>1004612</b>	
	4000K	2675lm	24°	<b>1004618</b>	
		2620lm	36°	<b>1004619</b>	
		2715lm	60°	<b>1004620</b>	

	2700K	2440lm	24°	<b>1004318</b>	
		2400lm	36°	<b>1004319</b>	
		2475lm	60°	<b>1004320</b>	
	3000K	2430lm	24°	<b>1004326</b>	
		2340lm	36°	<b>1004327</b>	
		2400lm	60°	<b>1004328</b>	
	4000K	2670lm	24°	<b>1004334</b>	
		2620lm	36°	<b>1004335</b>	
		2715lm	60°	<b>1004336</b>	

	2700K	2440lm	24°	<b>1004606</b>	
		2400lm	36°	<b>1004607</b>	
		2475lm	60°	<b>1004608</b>	
	3000K	2430lm	24°	<b>1004614</b>	
		2340lm	36°	<b>1004615</b>	
		2400lm	60°	<b>1004616</b>	
	4000K	2675lm	24°	<b>1004622</b>	
		2620lm	36°	<b>1004623</b>	
		2715lm	60°	<b>1004624</b>	

# NUMINOS® S



## PD

**Product details:**

220-240V ~50/60Hz | 250mA  
Premium LED with CRI>90  
Total wattage: 10.42W  
Material: aluminium/plastic

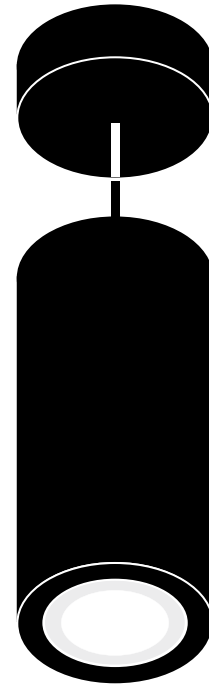
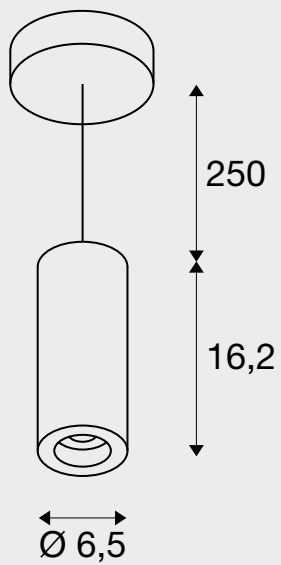
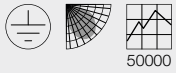

■ black

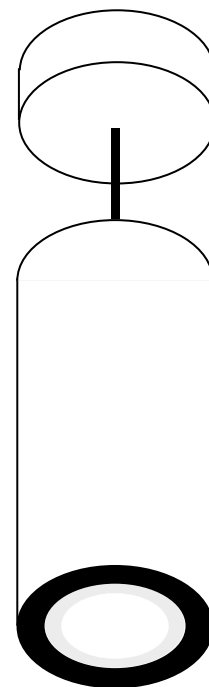

□ white



ITEM NO.

	2700K	980lm	24°	<b>1004146</b>	
		985lm	36°	<b>1004147</b>	
		980lm	60°	<b>1004148</b>	
	3000K	1020lm	24°	<b>1004154</b>	
		1020lm	36°	<b>1004155</b>	
		1020lm	60°	<b>1004156</b>	
	4000K	1100lm	24°	<b>1004162</b>	
		1100lm	36°	<b>1004163</b>	
		1100lm	60°	<b>1004164</b>	

	2700K	985lm	24°	<b>1004434</b>	
		985lm	36°	<b>1004435</b>	
		980lm	60°	<b>1004436</b>	
	3000K	1020lm	24°	<b>1004442</b>	
		1020lm	36°	<b>1004443</b>	
		1020lm	60°	<b>1004444</b>	
	4000K	1100lm	24°	<b>1004450</b>	
		1100lm	36°	<b>1004451</b>	
		1100lm	60°	<b>1004452</b>	

	2700K	985lm	24°	<b>1004150</b>	
		985lm	36°	<b>1004151</b>	
		980lm	60°	<b>1004152</b>	
	3000K	1020lm	24°	<b>1004158</b>	
		1020lm	36°	<b>1004159</b>	
		1020lm	60°	<b>1004160</b>	
	4000K	1100lm	24°	<b>1004166</b>	
		1100lm	36°	<b>1004167</b>	
		1100lm	60°	<b>1004168</b>	

	2700K	985lm	24°	<b>1004438</b>	
		985lm	36°	<b>1004439</b>	
		980lm	60°	<b>1004440</b>	
	3000K	1020lm	24°	<b>1004446</b>	
		1020lm	36°	<b>1004447</b>	
		1020lm	60°	<b>1004448</b>	
	4000K	1100lm	24°	<b>1004454</b>	
		1100lm	36°	<b>1004455</b>	
		1100lm	60°	<b>1004456</b>	

# NUMINOS® M



## PD

**Product details:**

220-240V ~50/60Hz | 500mA  
Premium LED with CRI>90  
Total wattage: 20.1W  
Material: aluminium/plastic

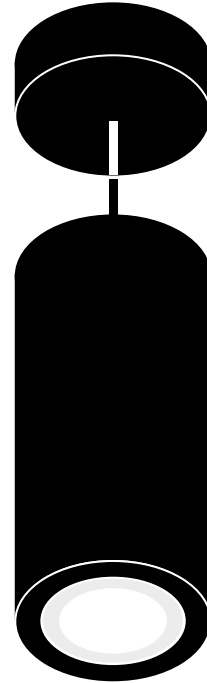
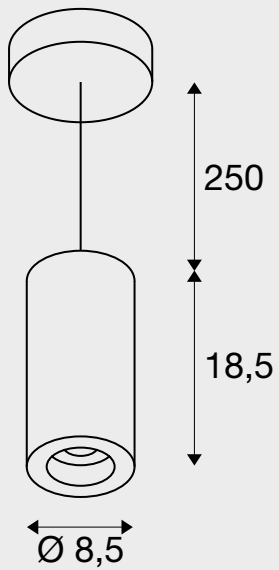

■ black

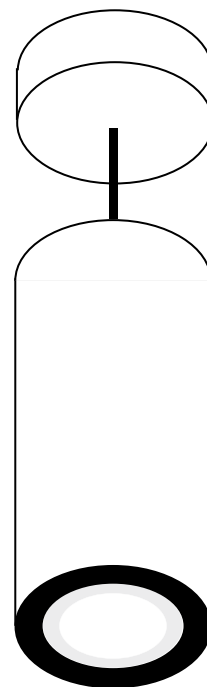

□ white





ITEM NO.

	2700K	1925lm	24°	<b>1004242</b>	
		1935lm	36°	<b>1004243</b>	
		1885lm	60°	<b>1004244</b>	
	3000K	1955lm	24°	<b>1004250</b>	
		1970lm	36°	<b>1004251</b>	
		1870lm	60°	<b>1004252</b>	
	4000K	2125lm	24°	<b>1004258</b>	
		2120lm	36°	<b>1004259</b>	
		2060lm	60°	<b>1004260</b>	

	2700K	1925lm	24°	<b>1004530</b>	
		1935lm	36°	<b>1004531</b>	
		1885lm	60°	<b>1004532</b>	
	3000K	1955lm	24°	<b>1004538</b>	
		1970lm	36°	<b>1004539</b>	
		1880lm	60°	<b>1004540</b>	
	4000K	2125lm	24°	<b>1004546</b>	
		2120lm	36°	<b>1004547</b>	
		2060lm	60°	<b>1004548</b>	

	2700K	1925lm	24°	<b>1004246</b>	
		1935lm	36°	<b>1004247</b>	
		1885lm	60°	<b>1004248</b>	
	3000K	1955lm	24°	<b>1004254</b>	
		1950lm	36°	<b>1004255</b>	
		1880lm	60°	<b>1004256</b>	
	4000K	2125lm	24°	<b>1004262</b>	
		2120lm	36°	<b>1004263</b>	
		2060lm	60°	<b>1004264</b>	

	2700K	1930lm	24°	<b>1004534</b>	
		1935lm	36°	<b>1004535</b>	
		1885lm	60°	<b>1004536</b>	
	3000K	1955lm	24°	<b>1004542</b>	
		1970lm	36°	<b>1004543</b>	
		1870lm	60°	<b>1004544</b>	
	4000K	2125lm	24°	<b>1004550</b>	
		2120lm	36°	<b>1004551</b>	
		2060lm	60°	<b>1004552</b>	

# NUMINOS® L



## PD

**Product details:**

220-240V ~50/60Hz | 700mA  
Premium LED with CRI>90  
System output: 28W  
Material: aluminium/plastic

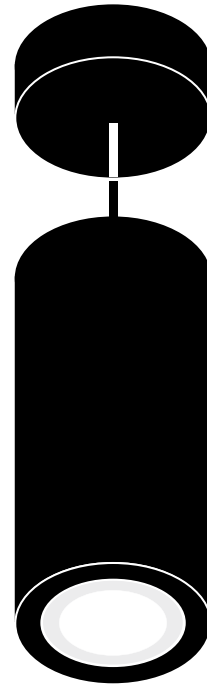
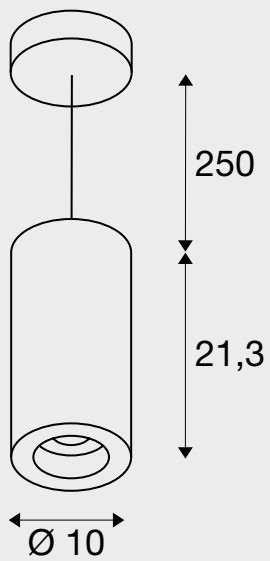
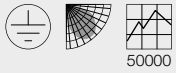

■ black

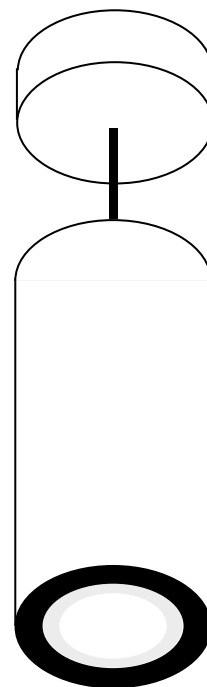

□ white



ITEM NO.

	2700K	2440lm	24°	<b>1004338</b>	
		2400lm	36°	<b>1004339</b>	
		2475lm	60°	<b>1004340</b>	
	3000K	2430lm	24°	<b>1004346</b>	
		2340lm	36°	<b>1004347</b>	
		2400lm	60°	<b>1004348</b>	
	4000K	2670lm	24°	<b>1004354</b>	
		2620lm	36°	<b>1004355</b>	
		2715lm	60°	<b>1004356</b>	

	2700K	2430lm	24°	<b>1004626</b>	
		2400lm	36°	<b>1004627</b>	
		2475lm	60°	<b>1004628</b>	
	3000K	2430lm	24°	<b>1004634</b>	
		2340lm	36°	<b>1004635</b>	
		2400lm	60°	<b>1004636</b>	
	4000K	2675lm	24°	<b>1004642</b>	
		2620lm	36°	<b>1004643</b>	
		2715lm	60°	<b>1004644</b>	

	2700K	2440lm	24°	<b>1004342</b>	
		2400lm	36°	<b>1004343</b>	
		2475lm	60°	<b>1004344</b>	
	3000K	2430lm	24°	<b>1004350</b>	
		2340lm	36°	<b>1004351</b>	
		2400lm	60°	<b>1004352</b>	
	4000K	2670lm	24°	<b>1004358</b>	
		2620lm	36°	<b>1004359</b>	
		2720lm	60°	<b>1004360</b>	

	2700K	2440lm	24°	<b>1004630</b>	
		2400lm	36°	<b>1004631</b>	
		2475lm	60°	<b>1004632</b>	
	3000K	2430lm	24°	<b>1004638</b>	
		2340lm	36°	<b>1004639</b>	
		2400lm	60°	<b>1004640</b>	
	4000K	2675lm	24°	<b>1004646</b>	
		2620lm	36°	<b>1004647</b>	
		2715lm	60°	<b>1004648</b>	











---



Anyone who has completed a project with SLV NUMINOS® downlights or spots can sit back and relax. Because the quality of the LEDs and drivers installed guarantees long life and lighting quality. When will you start your project with the SLV NUMINOS® lighting system?

# SYMBOLS KEY



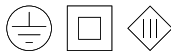

## PRODUCT CHARACTERISTICS

	<b>Dimmable with...</b> <ul style="list-style-type: none"> <li>· C = leading-edge <b>phase</b> dimmer</li> <li>· Dali = Dali busbar system</li> </ul>
	<b>Rotating and pivoting capacity in degrees:</b> <ul style="list-style-type: none"> <li>· Rotation range</li> <li>· Pivot range</li> </ul>
	<b>The half beam angle</b> Describes the beam angle in degrees. The smaller the angle, the more concentrated the light will be.
	<b>Power cable length</b> in cm
	<b>Average</b> lifespan of a lightbulb or light source in hours
	<b>UGR = Unified Glare Rating</b> The lower the UGR value, the lower the psychological glare.
	<b>Colour temperature</b>
	<b>Lumen</b>
	<b>Controller</b>





## SAFETY DETAILS

	<b>Protection categories</b> <ul style="list-style-type: none"> <li>· Protection class I / Protective conductor</li> <li>· Protection class II / protection through double or strengthened insulation</li> <li>· Protection category III / protection through low voltage</li> </ul>
	The <b>IK degree of shock resistance</b> is a measure of the resistance of the housing of electrical equipment to mechanical stress, especially impact stress.

## APPLICATION AREA · ASSEMBLY

	<b>IP protection rating</b> Indicates the suitability of electrical equipment for different environmental conditions.
	<b>Independent converter</b> (control equipment also for use outside of lights)
	Short-circuit protected <b>safety control equipment</b>
	<ul style="list-style-type: none"> <li>· For indoor use only</li> <li>· <b>Not suitable</b> for use indoors</li> </ul>

## SPECIAL SYMBOLS

	Indicates products that have been added to the catalogue for the <b>first time</b>
	Indicates products with <b>integrated LEDs</b>
	Indicates lights from a single lighting family
	You can easily add an optional driver (on/off, phase dimming, DALI) and suitable diffusers using the <b>colour coding system</b> .

### Please note:

A large part of the products shown in this catalogue are protected by trademarks, registered designs, utility models or patents. Any violation of these property rights or the use of text and layout design or copyrighted images without our authorisation will be prosecuted. The illustrations and information contained in this catalogue are for illustrative purposes only and are not legally binding in terms of colour, shape, design or technical details. All product descriptions and specifications are subject to alteration and errors.

All of the products in our range are subject to our strict quality assurance procedures and comply with generally applicable standards. This catalogue contains a general range and is not country specific. Any deviations from country-specific guidelines must be clarified before ordering. SLV cannot be held responsible for any deviations in terms of technical standards. All weights and dimensions are given in kg and cm respectively unless stated otherwise. We reserve the right to make technical alterations!

The presentation of our lights with realistic photos showing examples of use is possible thanks to the kind cooperation and agreement of the owners or designers of the environments displayed in the images. We would like to take this opportunity to thank all those who contributed to the creation and use of our photos by giving their consent!

You can find our entire range of products on our website [KS-Light.co.uk](http://KS-Light.co.uk) and in the current BIG WHITE® 2021 catalogue.

Image credits  
 SLV GmbH  
[www.gettyimages.de](http://www.gettyimages.de)

---

From hotels and offices to commercial or private rooms. From application to technology to detailed design: one great feature is that the modular downlights and spotlights can be configured exactly as required, depending on the design or space in question. And the more multifaceted your project is, the more you benefit from the SLV NUMINOS® lighting system.



KS Licht- u. Elektrotechnik GmbH  
Manderscheidstr. 8c  
D-45141 Essen

Tel.: +49 (0)201-89924-0  
Fax: +49 (0)201-89924-124

Internet: [www.KS-Germany.com](http://www.KS-Germany.com)  
Email: [Verkauf@KS-Germany.com](mailto:Verkauf@KS-Germany.com)